

Scanning Electromyography

Javier Navallas¹, Javier Rodríguez¹ and Erik Stålberg²

¹*Department of Electrical and Electronic Engineering,
Public University of Navarra, Pamplona*

²*Institute of Neuroscience, Department of Clinical Neurophysiology,
Uppsala University Hospital, Uppsala*
¹*Spain*
²*Sweden*

1. Introduction

The study of the anatomy and physiology of the motor unit has important implications in the diagnosis and follow-up of neuromuscular pathologies. Muscle action potentials allow the use of electrophysiological techniques based on electromyography (EMG) to make inferences about muscle structure, state and behaviour. Scanning EMG is one such technique that can record the temporal and spatial distribution of electrical activity of a single motor unit, allowing for deep insight into the structure and function of motor units.

In this chapter, we describe the scanning EMG technique in detail, both from a technical and clinical point of view. A brief review of the motor unit anatomy and physiology is provided in Section 2. The technique, the apparatus setup, the recording procedure and the signal processing required are described in Section 3. Key results of studies using scanning EMG are reviewed in Section 4, including findings related to motor unit organisation in normal muscle and how changes due to pathology are reflected using this electrophysiological technique. Finally, Section 5 provides some hints regarding the use of scanning EMG in research.

2. Investigation of the motor unit structure

The motor unit is the functional building block of skeletal muscle and the target of scanning EMG. In this section, the main concepts regarding the anatomy and physiology of the motor unit are described. Several electrophysiological techniques that allow the investigation of the structure of motor units are also introduced.

2.1 Motor unit anatomy

The motor unit is the smallest functional structure in skeletal muscle, comprising a motoneuron and the set of muscle fibres innervated by its axon. An action potential propagating through the axon eventually arrives at motor end-plates at the presynaptic side of the neuromuscular junctions. The electrical stimulus is then converted into a chemical signal that subsequently induces an action potential in the muscle fibre. This single fibre action potential (SFAP) propagates in both directions toward the ends of the muscle fibre,

inducing a contraction of the fibre itself. The motor unit fibres, i.e., all the muscle fibres belonging to the same motor unit, contract synchronously given upon receiving the motor control command from the same motoneuron through the arborisations of its axon.

Viewing the muscle longitudinally (Fig. 1), motor unit fibres generally run in parallel between two musculotendinous junctions, although some muscle fibres have tapered fibre-to-fibre ends (Lieber, 1992). Motor end-plates of corresponding neuromuscular junctions tend to concentrate in the central portion of the fibres, halfway between their two ends. In a muscle like the biceps brachii, motor end-plate zone occupies a thin strip about 6-10 mm in width (Aquilonius et al., 1982; Amirali et al., 2007). Action potentials generated under motor end-plates propagate through the muscle fibre at a certain conduction velocity (Stålberg, 1966); the conduction velocity of a muscle fibre is directly related to its diameter (Nandedkar & Stålberg, 1983a).

Views of muscle cross-sections (Fig. 2) reveal that fibres belonging to the same motor unit occupy only a fraction of the cross-section area (Kugelberg et al., 1970); this area is referred to as the motor unit territory, and is generally irregular, mainly rounded, although it has also been described to be oval-shaped (Bodine et al., 1988) or crescent-shaped closer to the fascia. Within this territory, fibres of the same motor unit are scattered and intermingled with fibres belonging to other motor units (Burke et al., 1974). Hence, territories of different motor units overlap. The size and shape of a single motor unit territory is considerably preserved throughout the entire length of the motor unit, as shown in three-dimensional reconstructions of complete motor units (Roy et al., 1995).

The technique employed to study motor unit cross-sections is based on glycogen depletion (Edström & Kugelberg, 1968). Briefly, a single axon is repeatedly stimulated to ensure that all the glycogen is depleted from the muscle fibres innervated by the axon. Next, the muscle is excised and stained with a glycogen reagent. In the microtome cross-section, the glycogen-depleted fibres that belong to the same motor unit can be traced. The glycogen depletion technique provides a picture of the motor unit cross-section that enables a

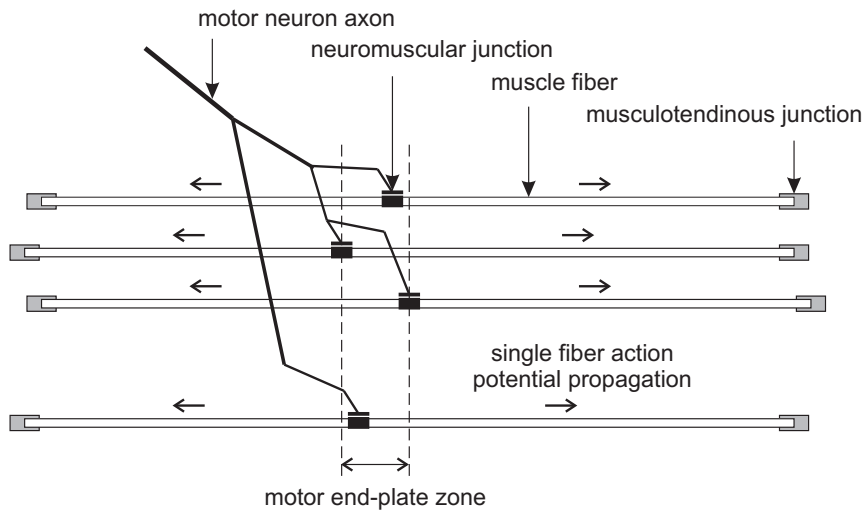

Fig. 1. A schematic representation of a motor unit with the motoneuron axon branching to innervate a set of muscle fibres.

visualisation of individual motor unit fibres. The technique also makes it possible to count individual motor unit fibres and to study their spatial distribution (Venema, 1994).

Several glycogen depletion studies have demonstrated that the number of motor unit fibres greatly varies not only among muscles (Enoka, 1995; Feinstein et al., 1955) but also within the same muscle, where the number of motor unit fibres can vary up to 10-fold (Bodine et al., 1988; Burke & Tsairis, 1973; Burke et al., 1974; Edström & Kugelberg, 1968). For example, in the medial gastrocnemius of the rat, the observed number of motor unit fibres ranges from 40 to 350 (Kanda & Hashizume, 1992). The area of the motor unit territory has also been measured in several glycogen depletion studies (Ansved et al., 1991; Bodine et al., 1988; Kanda & Hashizume, 1992; Rafuse & Gordon, 1996), which also show a broad range of variation. For example, motor unit territories of the tibialis anterior of the rat account for 10% to 24% of the muscle cross-sectional area, whereas territories of the soleus account for 25% to 75% of the cross-sectional area (Kugelberg et al., 1970).

Given the number of motor unit fibres and the area of the motor unit territory, the motor unit fibre density can be calculated (Kanda & Hashizume, 1992). Fibre density seems to be rather independent of the size of the motor unit (Weijs et al., 1993) and constant throughout the length of the motor units (Roy et al., 1995). However, fibre density can vary for different motor unit types, with smaller motor units having lower fibre densities (Kanda & Hashizume, 1992).

The spatial distribution of motor unit fibres within a motor unit territory has become a controversial issue. This spatial distribution has been described as uniform without localised collections (Burke et al., 1974), quasi-Gaussian (Miller-Larsson, 1980), evenly distributed (Willison, 1980), uniform (Gath & Stålberg, 1982), and random (Gates & Betz, 1993). A thorough statistical analysis of spatial point patterns obtained by glycogen depletion has provided more insight into this discrepancy. Short-range analysis based on adjacency tests and nearest-neighbour distributions suggest a random distribution (Bodine et al., 1988).

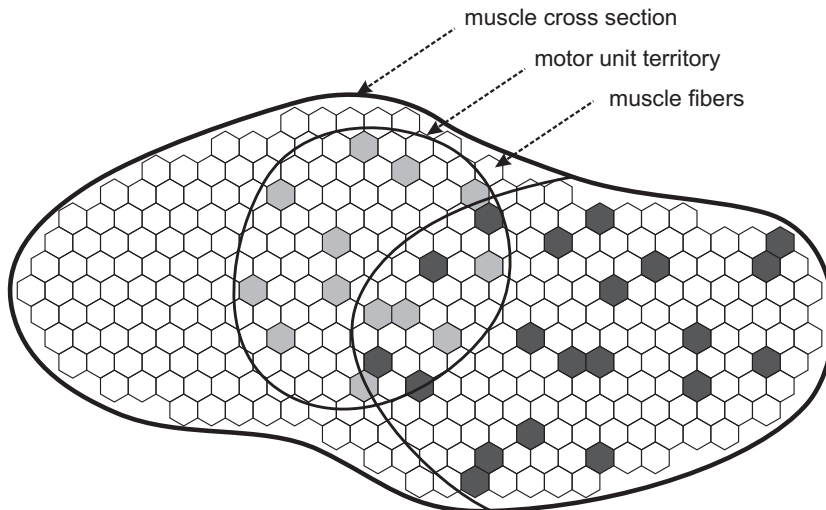

Fig. 2. A schematic representation of two motor units with overlapping territories within a muscle cross-section, and their corresponding muscle fibers.

However, long-range analysis based on quadrat analysis, point-to-nearest-neighbour distributions and inter-fibre distance distributions suggest the existence of holes within the territory and some degree of clustering in motor unit fibre distribution (Bodine-Fowler et al., 1990). The spatial clustering can be related to the axonal branching pattern established during the development of the neuromuscular system (Monti et al., 2001; Pfeifer & Friede, 1985). Other results show that, in the long-range, the randomness of the distribution may depend on the age and type of the motor unit (Ansved et al., 1991).

2.2 Electromyographic investigation of the motor unit structure

The electrical activity of the muscle can be recorded using intramuscular or surface electrodes. Intramuscular recordings are usually performed using needle electrodes. Depending on the type of needle and the recording procedure, EMG can measure the activity of muscle fibres by recording SFAPs, the activity of motor units by recording motor unit potentials (MUPs) or the activity of the entire muscle by recording the interference pattern.

2.2.1 Motor unit potentials obtained in concentric needle EMG

MUPs reveal many properties of motor unit structure because MUPs are made up of superimposed SFAPs of motor unit fibres. MUP characteristics depend on the number and relative positions of the muscle fibres generating the SFAPs and the temporal alignment of individual SFAPs (Nandedkar et al., 1988b).

The number of muscle fibres, especially within the closest uptake area of the electrode, determines the size of the resulting MUP (Nandedkar et al., 1988a). Several parameters reflect the size of MUPs, like the amplitude, the area, or the size-index (Sonoo & Stålberg, 1993). The duration of MUPs also reflects the number of fibres, but within a larger uptake area (Nandedkar et al., 1988b). A misalignment of the SFAPs contributing to an MUP increases the waveform complexity of the resulting MUP. This temporal misalignment can be caused by spatial dispersion of motor end-plates, temporal dispersion the initial depolarisation of motor end-plates, and differences in muscle fibre conduction velocities in different motor unit fibres (Navallas & Stålberg, 2009). The complexity of MUPs can be assessed with parameters like the number of phases, the number of turns (Pfeiffer & Kunze, 1992; Stålberg, 1986; Willison, 1964), or the irregularity coefficient (Zalewska & Husmanova-Petrusevich, 1995).

2.2.2 Specific techniques to estimate motor unit parameters

Quantitative analysis of MUPs is a valuable tool in diagnosis. In addition, there are other specific EMG techniques that allow us to estimate some of the physiological and anatomical parameters of the muscle and motor units. Because the glycogen depletion technique requires excising the muscle, it is unsuitable for human research, although some restricted experiments have been performed using muscle biopsies (Gollnick et al., 1973; Garnett et al., 1979). Hence, all available data pertaining to complete muscle cross-sections correspond to small mammals. Alternative techniques based on electrophysiological recordings have been developed allowing the investigation of motor unit structures in human muscles.

The number of motor units in a certain muscle can be estimated by incrementally stimulating the nerve while simultaneously recording the compound muscle action potential (CMAP) with a surface electrode, a technique called motor unit number estimation

(MUNE) (McComas et al., 1971). This basic concept was later developed into a number of MUNE methods.

The number of motor unit fibres cannot be estimated quantitatively using electrophysiological techniques, but a relative measure can be assessed using macro EMG (Stålberg, 1980; Stålberg & Fawcett, 1982). It has been demonstrated that the amplitude of motor unit potentials recorded using the macro EMG technique is highly correlated with the number of muscle fibres involved in the generation of the signal and hence the number of motor unit fibres (Nandedkar & Stålberg, 1983b; Roeleveld et al., 1997a, 1997b).

The density of motor unit fibres can also be estimated using single fibre EMG (Gath & Stålberg, 1982). This technique relies on the assumption of a homogeneous Poisson distribution of muscle fibres (Gath & Stålberg, 1981, 1982) and provides an average measure of fibre density of different motor units (Stålberg, 1986). Although this technique may average the differences in fibre densities for different motor units, recent studies in humans show no change in fibre density with a recruitment threshold up to 50% of the maximum voluntary contraction (Lukács et al., 2009).

2.2.3 Multipoint EMG techniques

The previously presented electrophysiological techniques share one thing in common: the recordings are made using electrodes with a single channel, and hence all the information is recorded from a single spatial location. Using special multilead electrodes, or multielectrodes, simultaneous recordings from different locations can be obtained, enhancing the scope of the electrophysiological technique for studying the muscle. A straightforward example is the use of a special multielectrode to assess muscle fibre conduction velocity *in situ* (Stålberg, 1966).

Using multielectrodes with recording sites lined up along the length of the needle, the main axis of the needle defines a recording corridor. It is common to position the corridor perpendicular to the muscle fibres, so that different recording sites gather information from different regions of the muscle cross-section or the motor unit territory under study.

One of the most straightforward applications of multipoint techniques is the investigation of motor unit territories. Motor unit territories have been studied using various EMG multielectrode configurations, one containing twelve 1.5 mm long leads distributed over 25 mm (Buchthal et al., 1957, 1959) and another containing 14 different recording sites of 25 μm diameter allowing 40 recording sites spaced 150 μm apart over 14 mm (Stålberg et al., 1976; Schwartz et al., 1976). Scanning EMG was developed as an extension of multielectrode techniques (Stålberg & Antoni, 1980), allowing higher flexibility both in the spatial interval of detection and in the type of electrode used. In this case, any type of conventional needle electrode can be used; therefore, the technique is not restricted to a single fibre-like recording.

In addition to the investigation of motor unit topography using scanning EMG (Diószeghy, 2002; Gootzen, 1990; Gootzen et al., 1992; Stålberg & Antoni, 1980; Stålberg & Diószeghy, 1991; Stålberg & Eriksson, 1987; Tonndorf, 1994), motor end-plate topography has also been studied using this technique (Navallas & Stålberg, 2009).

3. Scanning EMG technique

In this section, the methods, procedure, and set-up required to perform scanning EMG will be reviewed. Special attention will be paid to the recording procedure and the signal processing required to condition the signal after it is recorded.

3.1 Recording setup

The main objective of scanning EMG is to record the electrical activity of a motor unit from different locations along a scanning corridor as the needle electrode passes through the motor unit territory (Fig. 3). A very important aspect is that, although a single recording is made at each location, all recordings must be synchronised in relation to the firing of the motor unit, equivalent to simultaneously recording from all the sites. To extract the firing pattern of the motor unit, a second needle electrode, called the triggering needle, is inserted into the muscle. This electrode records localised activity, ideally from a single fibre, to minimise interference from other motor units. Hence, single fibre EMG needles or facial concentric needles are used for this purpose. A given motor unit is separated from others using an amplitude trigger.

If a concentric needle is used as the scanning electrode, the signal recorded in each location corresponds to an MUP. As the scanning needle moves through the scanning corridor, the relative geometry of motor unit fibres in relation to the active region of the electrode changes; hence, the recorded MUPs will be different, reflecting these changes. However, because the triggering needle is maintained at a fixed location, all the MUPs recorded by the scanning needle will be synchronised with the firing pattern of the motor unit.

The signals from both the triggering needle and the scanning needle are amplified and digitised, and transmitted to a personal computer running specific scanning EMG software (Fig. 4). This software must provide a way to establish a voltage threshold for the signal acquired from the triggering electrode. Whenever the signal exceeds this threshold voltage, the scanning software performs three operations:

1. Records a trace of the scanning signal within the predefined bounds of a temporal window, i.e., a buffer gathering the samples some milliseconds before and after the trigger event.

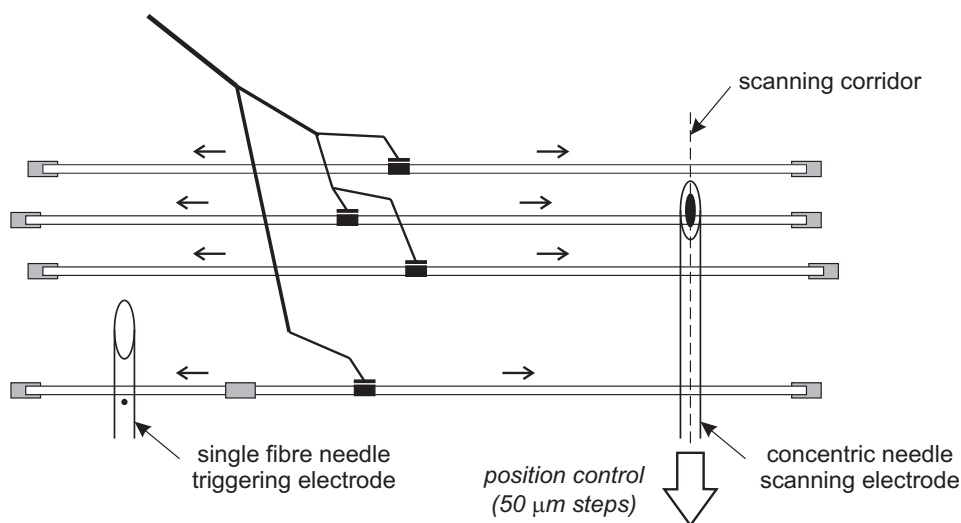

Fig. 3. A schematic representation of the recording procedure with the triggering needle in a fixed position and the scanning needle moving along the scanning corridor throughout the motor unit territory.

2. Sends a command to a micromotor controller to advance one step.
3. Waits until a new threshold event occurs. The micromotor controller is responsible for translating software commands into electrical signals that instruct the step-motor to advance a predefined distance, e.g., 50 μm .

The recorded signal is 2-dimensional in nature (Fig. 5(a)); the first dimension represents the spatial location of the recording in the scanning corridor and the second dimension represents the temporal duration of the recorded MUP. Both dimensions are discretised, the spatial dimension according to the step length controlled by the micromotor, and the temporal dimension according to the sampling time, i.e., the inverse of the sampling frequency of the acquisition system. Therefore, the signal can be thought of as a collection of MUPs from the same motor unit, where each trace is an individual MUP recorded from a different position along the scanning corridor, but also as a picture of the spatiotemporal distribution of the electric potential generated by the motor unit.

3.2 Recording procedure

In the first step, the triggering needle, a single fibre EMG electrode or facial concentric needle, is inserted to record the activity from one motor unit during slight voluntary contraction. The electromyographer should look for a stable waveform with good amplitude that is free of interference from other motor units. Next, the needle should be maintained in a fixed position to ensure a stable recording during the remainder of the process. The voltage level of the trigger must be adjusted so that a single trigger event is recorded each time the selected motor unit discharges.

The scanning needle is inserted a few centimetres away (20 mm is recommended) from the triggering electrode along the direction of the muscle fibres. The tip of the electrode must be sharp to ensure a smooth movement through the scanning corridor. The electrode must be inserted as close to perpendicular to the muscle fibres as possible (Stålberg & Antoni, 1980) to record from the actual cross-section of the muscle. Once the needle is inserted, the electromyographer should move it while looking for electrical activity synchronised with

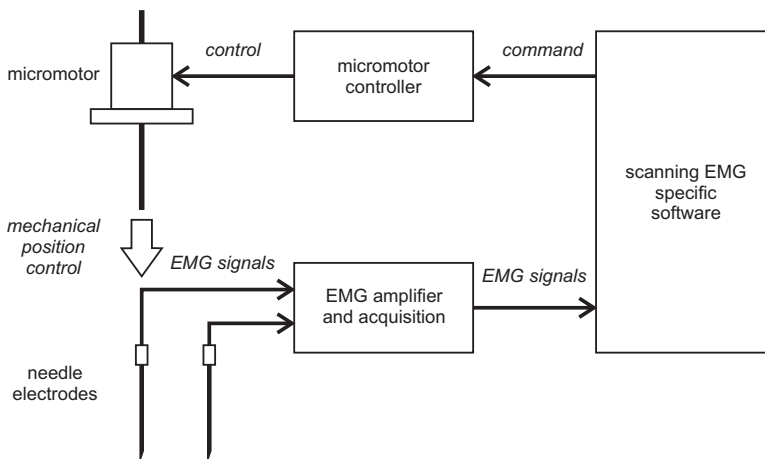

Fig. 4. A schematic representation of a scanning EMG system consisting in acquisition (needles and amplifier), processing, and control devices (micromotor and controller).

that of the triggering electrode (time-locked activity). To obtain good recordings and to ensure that the scanning needle is completely inside the motor unit territory, this time-locked activity should satisfy the same recording criteria applied to standard recordings; if a concentric needle is used for the scanning, the recorded signals should have high amplitude and a short rise-time.

Once the scanning needle is inside the motor unit territory, the electromyographer should push the needle until it reaches a position where spike activity is no longer detected. This ensures that we have completely passed through the motor unit territory. This procedure of selecting the triggering signal and finding synchronous activity with the scanning needle should take little more than one minute.

The next step is to physically connect the scanning needle to the step-motor, which should be mounted in a holder with an electrode grip and a wide-foot plate. The foot plate is held tightly against the skin over the muscle during the recording to ensure no relative movement between the step-motor and the muscle. Once the recording procedure begins, the step-motor pulls the scanning needle in small spatial increments until the recorded signal decays in amplitude or the needle exits the skin. The complete procedure should take less than five minutes.

3.3 Signal processing

The scanning EMG signal as initially recorded is a raw signal (Fig. 5(a)) that must be post-processed to obtain a cleaner version that is free of noise and interferences. There are two steps in the enhancement of the raw signal. First, a temporal filter is applied individually to each of the scanning traces (Stålberg & Antoni, 1980). A low-pass or band-pass filter can be applied to remove baseline noise produced by the needle or muscle movement and a band-pass filter will also subtract high frequency noise from the signal. The resulting signal (Fig. 5(b)) presents a smoother profile in the spatial dimension with fewer and smaller baseline jumps. Actual filter settings, like filter order and cut-off frequencies, will depend on the recording needle and should follow the recommendations for conventional recording using the needles.

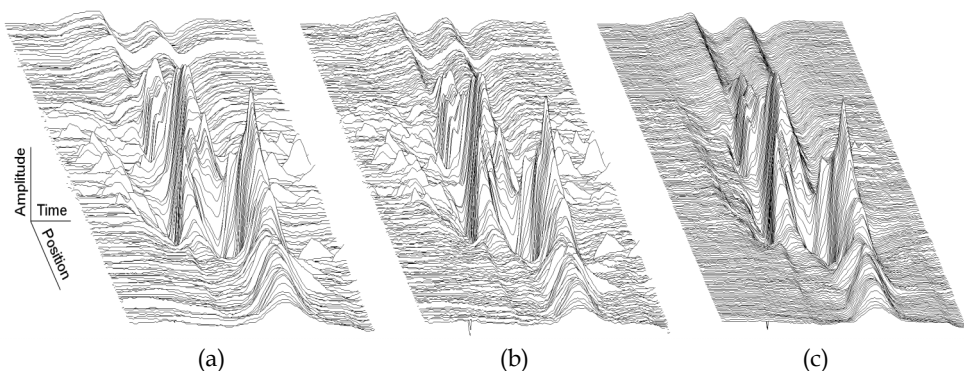

Fig. 5. A three-dimensional representation of a scanning EMG signal: (a) a raw signal, (b) the pervious signal filtered in the temporal domain, and (c) the previous signal filtered in the spatial domain.

Significant interference due to the coactivation of other motor units may still exist in the signal, represented by superimposed MUPs scattered alongside the MUP being tracked. However, superimposed discharges are not synchronised with the firing of the tracked motor unit. Therefore, these interfering discharges are not consistently repeated and, in a trace corrupted with such an artefact, superimposed MUPs are usually found between two clean traces in the spatial domain. For this reason, a median filter is applied in the spatial dimension during the second processing step (Stålberg & Antoni, 1980). Median filters preserve smoothly changing values of synchronised activity in motor units being tracked, removing all artefacts generated by other motor units (Fig. 5(c)).

Although median filtering is a very useful technique to eliminate interfering MUPs, its influence on the signal it is not negligible. The larger the size of the median filter, the greater the reduction in the amplitude of the peaks compared to the raw data. When a 3-point median filter is used, peaks are reduced by about 10%, and when a 5- or 7-point median filter is used, peaks are reduced up to 30% (Gootzen, 1990). This should be taken into account when extracting quantitative data from the signals.

4. Scanning EMG results

Scanning EMG provides valuable information not only about the territory and arrangement of muscle fibres within a motor unit, but also about the spatiotemporal distribution of the electrical activity of a motor unit, information no other EMG technique can provide (Diószeghy, 2002). We will introduce some key aspects for qualitative interpretation of scanning EMG signals and several parameters for quantitative analysis.

4.1 Interpretation of the scanning EMG signal

In the most straightforward interpretation, a scanning EMG signal is a collection of MUPs recorded from slightly different locations through a scanning corridor. Hence, it shows the evolution of MUPs as the location of the needle electrode changes relative to the motor unit fibres of the motor unit being tracked. However, a scanning EMG signal can also be interpreted as a picture of the spatiotemporal distribution of the electric potential generated by a motor unit. Fig. 6 shows a 2-dimensional signal as a contour map that allows us to distinguish between peaks and valleys corresponding to the negative and positive phases of MUPs. In this figure, four spatial locations within the corridor are selected, and the corresponding traces representing the MUPs recorded at these sites are depicted.

Due to the recording procedure, the first part of the scanned recording corresponds to a section of the corridor outside the motor unit territory. In this case, the recording tip of the needle electrode is too far away from the generators to record their signals. However, the cannula, which is used as reference electrode in concentric needle recordings, is almost completely inside the motor unit territory. The result is that an inverted potential is recorded, similar to that of a macro EMG recording (first selected MUP in Fig. 6). This causes a trough at the beginning of the scan referred to as the cannula effect. In this way, it is possible to obtain the equivalent of an inverted macro EMG recording from the motor unit under study by averaging 50 to 100 traces that are recorded before the tip of the needle is inside the motor unit territory (Stålberg & Diószeghy, 1991). It is important to note that this method is not identical to conventional macro EMG, as the cannula used in the scanning procedure may not be partially insulated (Stålberg & Diószeghy, 1991).

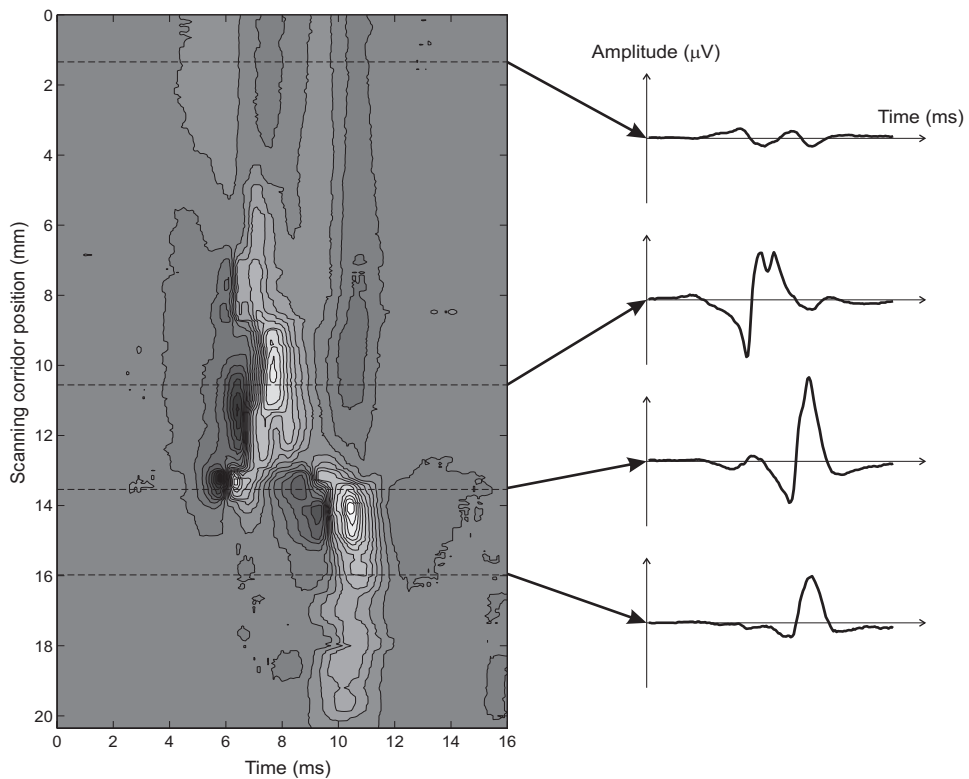

Fig. 6. A topographic representation of a scanning EMG signal in a contour plot (left) and selected MUPs at four different positions along the scanning corridor (right), with the uppermost MUP being a clear example of the cannula effect.

Once the active area of the electrode enters the motor unit territory, the recorded electric field increases and takes the shape of a conventional MUP (second to fourth MUPs in Fig. 6). Remarkably, the high variability of MUPs becomes apparent in scanning EMG recordings; as we move through the scanning corridor, the MUP waveform changes dramatically, reflecting the changes in the geometrical disposition of the set of generators, i.e., the set of motor unit fibres.

The length of the recording is characterised by regions of high activity separated by regions where the potential amplitude decays considerably. Regions of high activity are called motor unit fractions, or simply fractions, and the regions of low activity are called silent areas.

Clearly, the fractions correspond to regions close to motor unit fibres, whereas silent areas correspond to holes in the motor unit territory, or regions depleted of motor unit fibres. This arrangement of motor unit fibres, where motor unit fibres are not evenly distributed throughout the motor unit territory, is in agreement with glycogen depletion findings suggesting a certain degree of clustering of the muscle fibres within its motor unit territory (Bodine et al., 1998). Furthermore, fractions observed in scanning EMG recordings from

normal muscle more commonly present distinct latencies rather than spatial separation. This observation points to the existence of different average temporal latencies of fibres belonging to different fractions (Stålberg, 1986; Navallas & Stålberg, 2009) and supports the hypothesis that each fraction represents a set of fibres innervated by a common axonal branch; therefore, the end-plates of these fibres will be in close proximity to one another compared to the overall motor end-plate zone dispersion (Stålberg, 1986; Nandedkar & Stålberg, 1986; Stålberg & Diószeghy, 1991; Navallas & Stålberg, 2009). Sudden amplitude changes may also occur in scanning EMG profiles. These can be produced either by small uncontrolled jumps of the scanning needle or by changes in the properties of the volume conductor as the needle passes through a tendon layer or through a fascia (Stålberg & Eriksson, 1987; Diószeghy, 2002).

4.2 Analysis and parameterisation of the signal

Quantification of the EMG waveforms establishes objective criteria for comparing signals and for subsequent diagnosis. Several parameters have been proposed to quantify scanning EMG waveforms, most based on characteristics that cannot be observed in conventional EMG recordings. It is important to note that because the individual traces of scanning signals are MUPs themselves, all the conventional MUP parameters, like amplitude, area, duration, size index, etc., can be calculated in these traces. However, we will focus on specific scanning EMG parameters that exploit the two-dimensional nature of the signal and the recording through the spatial corridor.

4.2.1 Length of the motor unit cross-section

The length of the motor unit cross-section (Hilton-Brown & Stålberg, 1983a, 1983b ; Stålberg, 1986) is defined as the maximal distance between traces with amplitudes of at least 50 μV (Fig. 7). This distance represents an estimation of the length of the scanning corridor that runs inside the motor unit territory, given that as soon as the active area of the electrode enters the territory, the amplitude of the recorded MUP will exceed the 50 μV threshold. The length of the motor unit cross-section can alternatively be defined as the length between the two most distant traces with amplitudes above 15% of the maximum positive amplitude of the scan (Gootzen, 1990). However, this definition may under- or overestimate the measured length because it is relative to the amplitude of the largest MUP recorded during the scanning procedure (Stålberg & Diószeghy, 1991).

Measured length can be used as a lower bound to estimate the diameter of motor unit territories (Stålberg, 1986). It has to be noted that an actual estimation of the motor unit diameter is not feasible with this parameter, as it is not evident whether or not the recording has been done through a maximal arc of the motor unit territory bounds (Fig. 8). Statistically, the average measured length of the motor unit cross-section would be 87% of the true transverse motor unit diameter for territories with round cross-sections (Stålberg & Eriksson, 1987).

4.2.2 Number and length of silent areas

The number of silent areas (Stålberg, 1986) is defined as the number of areas within the length of a motor unit cross-section with amplitudes below 50 μV (Fig. 7). The length of the silent areas corresponds to the length measured over the cross-section of the corresponding silent areas (Stålberg and Diószeghy, 1991).

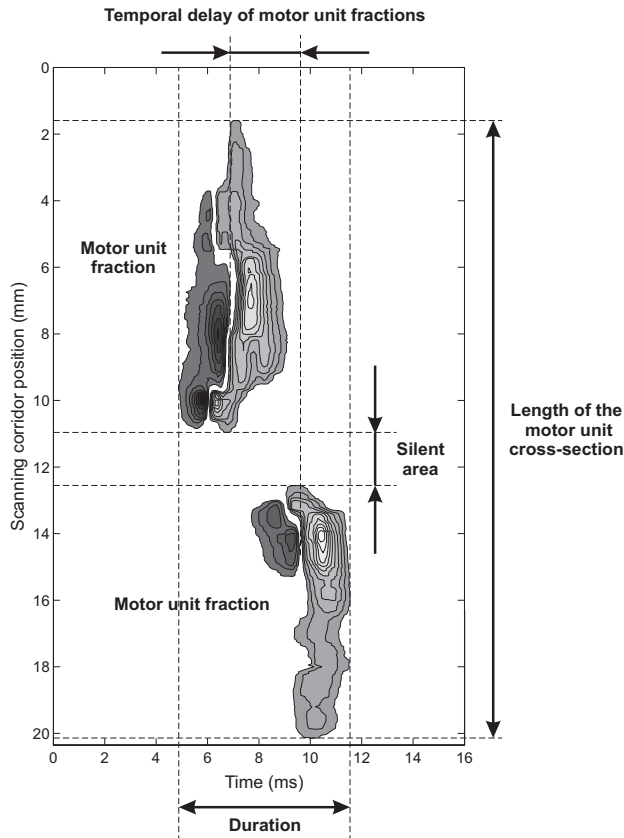

Fig. 7. Parameterisation of a scanning EMG signal after removing the signal content below the $50 \mu\text{V}$ threshold for the sake of clarity.

4.2.3 Number and length of fractions

The number of fractions (Stålberg, 1986) is defined as the number of areas within the length of a motor unit cross-section with amplitudes above $50 \mu\text{V}$ and either separated by silent areas or having clearly separated maxima along the time axis (Fig. 7). The length of the fractions corresponds to the length measured over the cross-section of the corresponding motor unit fractions (Navallas & Stålberg, 2009).

4.2.4 Number and length of polyphasic fractions

An MUP is defined a polyphasic or complex if it has more than 4 phases or more than 5 turns. Hence, the number of fractions containing polyphasic MUPs can be counted (Stålberg, 1986), and the overall length of these fractions can be measured (Stålberg & Diószeghy, 1991).

4.2.5 Temporal dispersion of fractions

The temporal dispersion of the motor unit fractions (or motor unit time dispersion) is defined as the latency difference between the earliest and latest MUP traces recorded within

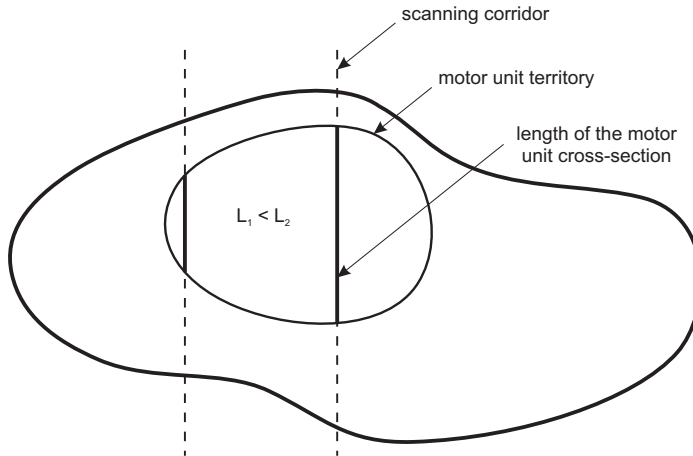

Fig. 8. An illustration of the problem regarding motor unit territory diameter estimation: how can we ensure that we are crossing a maximal arc?

a motor unit cross-section, where the latency of an MUP is measured at the steepest downward slope (Gootzen, 1990) or at the time point corresponding to 50% of the energy of the envelope signal (Navallas & Stålberg, 2009). Temporal dispersion measurements are slightly affected when the needle is not inserted orthogonally into the muscle fibres, which can produce up to 0.5 ms of error for a 20° angle deviation (Gootzen et al., 1992).

It is important not to confuse this parameter with the temporal dispersion of individual SFAPs contributing to MUPs when observed from a single point (Gootzen, 1990). Rather, this parameter gives information about the average temporal dispersion of groups of SFAPs contributing to different fractions, which reside in different parts of motor unit territories and are observed essentially from different locations throughout the scanning corridor (Navallas & Stålberg, 2009).

4.2.6 Depth of the motor unit territory

Although not a parameter of a scanning EMG signal, it is important to note that the depth of the motor unit territory under study can also be estimated using the scanning procedure. A stereotactic location system can be used to assess the location of the moving EMG needle relative to the internal tendinous boundaries within the muscle under study (Tonndorf, 1994) by combining magnetic resonance imaging, scanning needle electrode optical tracking, and stereotactic reconstruction.

Furthermore, by taking into account the beginning and ending positions of the scanning electrode and the number of steps taken for each trigger, the electrode location can be estimated. Using this information, the position of the motor unit can be defined as the position in the scans corresponding to a contribution of 50% of the signal within the length of the cross-section (Roeleveld et al., 1997a, 1997b). The position of the motor unit provides an estimation of the depth of the centre of the motor unit territory.

4.3 Findings in normal conditions

A limited number of muscle types has been investigated using scanning EMG, including the biceps brachii (Hilton-Brown & Stålberg, 1983a, 1983b; Stålberg & Diószeghy, 1991; Navallas

& Stålberg, 2009), the tibialis anterior (Hilton-Brown & Stålberg, 1983a, 1983b; Stålberg & Diószeghy, 1991), the masseter (Stålberg & Eriksson, 1987), and the quadriceps (Gootzen, 1990; Gootzen et al., 1992).

The length of the motor unit cross-section has been measured in normal conditions in various muscles. In the biceps brachii, the length of the motor unit cross-section has been reported as 6.0 ± 3.9 mm (mean \pm SD) (Hilton-Brown & Stålberg, 1983a, 1983b), 4.64 ± 2.14 mm with a range of 1.69 to 10.17 mm ($n=59$) (Stålberg & Diószeghy, 1991), and 4.39 ± 2.29 mm with a range of 1.55 to 10.70 mm (Navallas & Stålberg, 2009). In the tibialis anterior, the length has been reported as 7.9 ± 1.3 mm (Hilton-Brown & Stålberg, 1983a) and 5.26 ± 2.18 mm with a range of 1.53 to 10.33 mm ($n=70$) (Stålberg & Diószeghy, 1991). In the masseter, the length has been reported as 3.7 ± 0.6 mm with a range of 0.6 to 12.5 mm (Stålberg & Eriksson, 1987) and 3.7 ± 2.3 mm with a range of 0.4 to 13.1 mm (Tonndorf et al, 1994b). Finally, in the quadriceps, the length has been reported with a range of 2.0 to 8.0 mm (Gootzen, 1990; Gootzen et al., 1992).

As previously stated, motor unit fractions and silent areas, which are structural properties that can only be observed using scanning EMG, suggest that adjacent motor unit fibres have adjacent motor end-plates with a lower spatial dispersion than the overall muscle motor end-plate zone width (Navallas & Stålberg, 2009). Each fibre group would correspond to a distinct axonal branch reflecting a distinct motor unit fraction in a scanning EMG recording (Stålberg, 1986; Navallas & Stålberg, 2009).

The number of fractions and silent areas gives an indication of the degree of grouping or clustering of motor unit fibres in a normal muscle. The number of fractions generally ranges from 1 to 4 fractions per scan (Stålberg, 1986), although exact counts may vary among muscles. In the biceps brachii, 3.25 ± 1.49 (mean \pm SD) fractions with the range of 1 to 6 fractions (Stålberg & Diószeghy, 1991) and 1.65 ± 1.02 fractions with a range of 1 to 5 fractions (Navallas & Stålberg, 2009) have been reported. In the tibialis anterior, 3.73 ± 1.74 fractions with a range of 1 to 8 fractions have been reported (Stålberg & Diószeghy, 1991). The number of silent areas has also been measured in the biceps brachii. A mean of 0.5 silent areas (Hilton-Brown & Stålberg, 1983b) and 0.15 ± 0.36 silent areas with a range of 0 to 1 (Stålberg & Diószeghy, 1991) have been reported. In the tibialis anterior, a mean of 0.2 silent areas (Hilton-Brown & Stålberg, 1983b) and 0.19 ± 0.47 silent areas with a range of 0 to 2 (Stålberg & Diószeghy, 1991) have been reported. The length of the individual motor unit fractions in the biceps brachii has been reported as 1.56 ± 1.07 mm with a range of 0.35 to 5.10 mm (Navallas & Stålberg, 2009).

Furthermore, temporal dispersion between fractions (see section 4.2.5) has provided valuable information about innervation patterns of motor units. The temporal dispersion measured in the biceps brachii has been reported as ranging from 0.5 to 5.0 ms (Gootzen, 1990) and 0.55 ± 0.98 ms with a range of 0.01 to 4.70 ms (Navallas & Stålberg, 2009). These temporal differences can be justified by assuming 1) a variation in the depolarisation delay in different fractions due to length differences among the innervating axonal branches and/or 2) different mean motor end-plate positions along the muscle fibres (Fig. 9) (Navallas & Stålberg, 2009).

The complexity of MUPs, measured in terms of the number of phases, number of turns, or irregularity coefficient, is a key feature used to distinguish normal conditions from pathology (Zalewska et al., 2004). In scanning EMG recordings from normal muscles, the complexity parameters of individual MUP traces extracted from a scan are within the range of values of conventional multi-MUP studies. The following complexity parameters of the

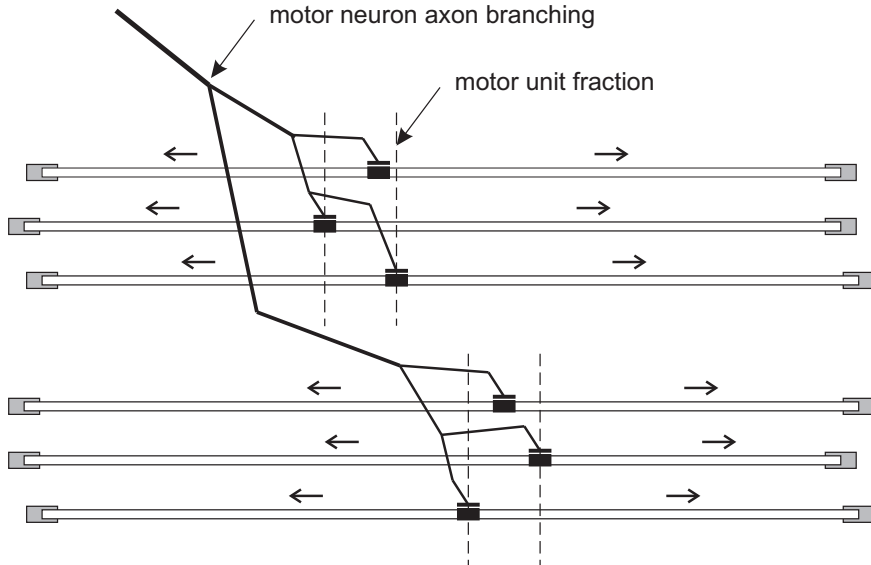

Fig. 9. The motor unit fractions hypothesis states that motor unit fractions are representing groups of motor unit fibres innervated by different axonal branches that may have a shifted motor end-plate location.

biceps brachii have been reported: a mean (\pm SD) of 3.26 ± 1.18 phases, a mean of 4.17 ± 1.87 turns, and an irregularity coefficient of 3.61 ± 0.82 (Navallas & Stålberg, 2009). The number of polyphasic fractions reported in the biceps brachii was 0.21 ± 0.41 with a range of 0 to 1 polyphasic sections (Stålberg & Diószeghy, 1991), and the number of polyphasic fractions reported in the tibialis anterior was 0.41 ± 0.58 with a range of 0 to 2 polyphasic sections (Stålberg & Diószeghy, 1991). Therefore, the proportion of polyphasic fractions, as the proportion of polyphasic MUPs in conventional quantitative EMG studies, is relatively low in normal conditions.

4.4 Findings in pathological conditions

In a study conducted with subjects suffering from a variety of neuropathies (including ALS, SMA, postpolio, polyneuropathy, and syringomyelia), the most relevant changes in scanning EMG recordings taken from the biceps brachii and the tibialis anterior were related to an increased complexity of motor units (Stålberg & Diószeghy, 1991). Specifically, the length of motor unit cross-sections and the number of fractions were slightly increased in both muscles, although only significant in the tibialis anterior. The number and length of silent areas were not significantly different from controls. Finally, the number and the length of polyphasic sections were significantly increased in both muscles.

These changes in scanning parameters are related to a reorganisation of motor units that occurs in neuropathies. Reorganisation is essentially due to reinnervation by collateral sprouting of surviving axons (Kugelberg et al., 1970). During reinnervation, collateral sprouts tend to be confined to the originally innervated fascicles, what derives in the observation of non increased motor unit cross-sections (Stålberg & Sanders, 1984). The increase in the number of motor unit fibres creates more compact and dense motor units;

therefore, the increase in motor unit fibres does not lead to a significant increase in silent areas or motor unit fractions (Diószeghy, 2002). However, reinnervation does cause an increase in fibre diameter variation and the dispersion of motor end-plates, which results in an increased waveform complexity throughout the region and an increased length and number of polyphasic fractions (Stålberg & Diószeghy, 1991).

Another study conducted with subjects suffering from various myopathies (including muscular dystrophies and polymyositis) found that the most relevant changes in scanning EMG recordings of the biceps brachii and the tibialis anterior were related to increased fractioning and an increased complexity of motor units (Stålberg & Diószeghy, 1991). The length of motor unit cross-sections was not significantly different from normal muscles. The number of fractions was significantly increased in both muscles. The length and number of silent areas was also significantly increased in both muscles, although more prominently in the tibialis anterior. Note that this significant change among myopathies is not identifiable using conventional EMG because, using this technique, an area with no activity cannot be ascribed to loss of muscle fibres within a given motor unit. Finally, the length and number of polyphasic sections was also significantly increased in both muscles. These results agree with previous findings in patients suffering from muscular dystrophy. The muscles of these patients showed no difference in the length of motor unit cross-sections but showed an increased number of silent areas and an increased variability in the amplitude profile and shape of scanning EMG recordings (Hilton-Brown & Stålberg, 1983a, 1983b).

Myopathic processes cause several structural changes, including fibre loss, fibre atrophy and hypertrophy, and fibre splitting (Hilton-Brown & Stålberg 1983a). Hence, an increased fibre grouping due to fibre splitting and an appearance of motor unit territories depleted of motor unit fibres explains the increased number of fractions and length and number of silent areas (Stålberg & Diószeghy, 1991; Diószeghy, 2002). The increased variability in fibre diameter due to hypertrophy and atrophy causes increased MUP complexity, which is observed as an increased length and number of the polyphasic fractions within scans (Diószeghy, 2002).

One study of juvenile myoclonic epilepsy (Gooker et al., 2009b, 2010) revealed that patients suffering from the disorder have enlarged motor unit territories compared to healthy subjects. The enlargement of motor units is not due to a reinnervation process but to a preponderance of genetically determined large lower motor units (Ertas et al., 1997).

Another study of both neuropathic and myopathic muscles (Gootzen, 1990; Gootzen et al., 1992) measured the length of motor unit cross-sections and the temporal dispersion of motor unit fractions in the biceps brachii. The results showed that scans from both patients and healthy subjects largely overlap with respect to the length of cross-sections. Both neuropathic and myopathic recordings showed an increased temporal dispersion of fractions. The temporal dispersion ranged from 0.5 ms to 6 ms in scans of healthy patients, 0.5 ms to 9 ms in scans of neuropathic patients, and 1 ms to 12.5 ms in scans of myopathic patients. Additionally, a strong positive correlation between the length of cross-sections and the temporal dispersion of the fractions was detected for the neuropathic group. Using these two parameters as a diagnostic tool, normal and pathological scans can be reliably separated, although parameters fail to distinguish between myopathy and neuropathy (Gootzen, 1990; Gootzen et al, 1992).

5. Future trends

The scanning EMG technique has evolved as a versatile and informative tool for the investigation of motor unit architecture. In combination with other EMG techniques, such as

fibre density measurements, a detailed description of motor units can be obtained using scanning EMG (Stålberg, 1986).

Further research should focus on extracting more information from the scanning signals. For example, the analysis of pathological signals suggests that parameters describing motor unit integrity, the complexity of motor end-plate zones or the variability in propagation velocities may soon be identified (Gootzen et al., 1992).

Several possible applications have been suggested in previous studies. Scanning EMG may be used to quantify the background activity of a muscle for a given degree of contraction to determine whether some regions account for many recruited motor units while others remain inactive (Stålberg, 1986). This could lead to studies relating functional compartmentalisation and recruitment strategies of muscles.

It has been also suggested that scanning EMG may be applied to verify volume conductor models by observing SFAPs (Gootzen, 1990), as scan recording profiles provide a reliable description of amplitude decay with distance. However, care must be taken to eliminate possible fibre movements to ensure there is no potential blocking.

In conclusion, scanning EMG is a valuable technique used in studies of motor unit anatomy and physiology and to study the structural and functional parameters in normal muscle and the changes that occur in pathology.

6. Acknowledgment

This work was supported by the Regional Health Ministry of the Government of Navarre under the project 1312/2010.

7. References

- Amirali, A., Mu, L., Gracies, JM., & Simpson, DM. (2007) Anatomical localization of motor endplate bands in the human biceps brachii. *J Clin Neuromuscul Dis*, Vol. 9, No. 2, pp. 306-312.
- Ansved, T., Wallner, P., & Larsson, L. (1991). Spatial distribution of motor unit fibres in fast- and slow-twitch rat muscles with special reference to age. *Acta Physiol Scand*, Vol. 143, No. 3, pp. 345-354.
- Aquilonius, SM., Arvidsson, B., Askmark, H., & Gillberg, PG. (1982). Topographical localization of end-plates in cryosections of whole human biceps muscle. *Muscle Nerve*, Vol. 5, No. 5, pp. 418.
- Bodine, SC., Garfinkel, A., Roy, RR., & Edgerton, VR. (1988). Spatial distribution of motor unit fibres in the cat soleus and tibialis anterior muscles: local interactions. *J Neurosci*, Vol. 8, No. 6, pp. 2142-2152.
- Bodine-Fowler, S., Garfinkel, A., Roy, RR., & Edgerton, VR. (1990). Spatial distribution of muscle fibres within the territory of a motor unit. *Muscle Nerve*, Vol. 13, No. 12, pp. 1133-1145.
- Buchthal, F., Erminio, F., & Rosenfalck, P. (1959). Motor unit territory in different human muscles. *Acta Physiol Scand*, Vol. 45, No. 1, pp. 72-87.
- Buchthal, F., Guld, C., & Rosenfalck, P. (1957). Multielectrode study of the territory of a motor unit. *Acta Physiol Scand*, Vol. 39, No. 1, pp 83-104.
- Burke, RE., Levine, DN., Salzman, M., Tsairis, P. (1974). Motor units in cat soleus muscle: physiological, histochemical and morphological characteristics. *J Physiol*, Vol. 238, No. 3, pp. 503-514.

- Burke, RE., & Tsairis, P. (1973). Anatomy and innervation ratios in motor units of cat gastrocnemius. *J Physiol*, Vol. 234, No. 3, pp. 749-765.
- Diószeghy, P. (2002). Scanning electromyography. *Muscle Nerve*, No. S11, pp. 66-71.
- Edström, L., & Kugelberg, E. (1968). Histochemical composition, distribution of fibres and fatiguability of single motor units. Anterior tibial muscle of the rat. *J Neurol Neurosurg Psychiatry*, Vol. 31, No. 5, pp. 424-433.
- Enoka, RM. (1995). Morphological features and activation patterns of motor units. *J Clin Neurophysiol*, Vol. 12, No. 6, pp. 538-559.
- Ertas, M., Uludag, B., & Araç, N., Ertekin, C., & Stålberg E. (1997). A special kind of anterior horn cell involvement in juvenile myoclonic epilepsy demonstrated by macro electromyography. *Muscle Nerve*, Vol. 20, No. 2, pp. 148-152.
- Feinstein, B., Lindegard, B., Nyman, E., & Wohlfart, G. (1955). Morphologic studies of motor units in normal human muscles. *Acta Anat (Basel)*, Vol. 23, No. 2, pp. 127-142.
- Garnett, RAF., O'Donovan, MJ., Stephens, JA., & Taylor, A. (1979). Motor unit organization of human medial gastrocnemius. *J Physiol*, Vol. 287, pp. 33-43.
- Gates, HJ., & Betz, WJ. (1993). Spatial distribution of muscle fibers in a lumbrical muscle of the rat. *Anat Rec*, Vol. 236, No. 2, pp. 381-389.
- Gath, I., & Stålberg, E. (1979). Measurements of the uptake area of small-size electromyographic electrodes. *IEEE Trans Biomed Eng*, Vol. 26, No. 6, pp. 374-376.
- Gath, I., & Stålberg, E. (1981). In situ measurement of the innervation ratio of motor units in human muscles. *Exp Brain Res*, Vol. 43, No. 3-4, pp. 377-382.
- Gath, I., & Stålberg, E. (1982). On the measurement of fibre density in human muscles. *Electroencephalogr Clin Neurophysiol*, Vol. 54, No. 6, pp. 699-706.
- Goker, I., Baslo, MB., Ertas, M., & Ulgen, Y. (2009a). Design of an experimental system for scanning electromyography method to investigate alterations of motor units in neurological disorders. *Digest Journal of Nanomaterials and Biostructures*, Vol. 4, No.1, pp. 133-139
- Goker, I., Baslo, MB., Ertas, M., & Ulgen, Y. (2009b). Motor unit territories in juvenile myoclonic epilepsy patients. *Conf Proc IEEE Eng Med Biol Soc*, 2009, pp. 819-822.
- Goker, I., Baslo, MB., Ertas, M., & Ulgen, Y. (2010). Large motor unit territories by scanning electromyography in patients with juvenile myoclonic epilepsy. *J Clin Neurophysiol*, Vol. 27, No. 3, pp. 212-215.
- Gollnick, PD., Armstrong, RB., Saubert, CW., Sembrowich, WL., Shepherd, RE., & Saltin, B. (1973). Glycogen depletion patterns in human skeletal muscle fibers during prolonged work. *Pflugers Arch*, Vol. 344, No. 1, pp. 1-12.
- Gootzen, TH. (1990). *Electrophysiological investigation of motor unit structure by means of scanning EMG*, University of Nijmegen, ISBN 90-9003335-1, Nijmegen.
- Gootzen, TH., Vingerhoets, DJ., & Stegeman, DF. (1992). A study of motor unit structure by means of scanning EMG. *Muscle Nerve*, Vol. 15, No.3, pp. 349-357.
- Hilton-Brown, P., & Stålberg, E. (1983a). The motor unit in muscular dystrophy, a single fibre EMG and scanning EMG study. *J Neurol Neurosurg Psychiatry*, Vol. 46, No. 11, pp. 981-995.
- Hilton-Brown, P., & Stålberg, E. (1983b). Motor unit size in muscular dystrophy, a macro EMG and scanning EMG study. *J Neurol Neurosurg Psychiatry*, Vol. 46, No. 11, pp. 996-1005.

- Kanda, K., & Hashizume, K. (1992). Factors causing difference in force output among motor units in the rat medial gastrocnemius muscle. *J Physiol*, Vol. 448, pp. 677-695.
- Kugelberg, E., Edström, L., & Abbruzzese, M. (1970). Mapping of motor unit in experimentally reinnervated rat muscle. *J Neurol Neurosurg Psychiatry*, Vol. 197, No. 33, pp. 319-329.
- Lieber, RL. (1992). *Skeletal Muscle Structure and Function: Implications for Rehabilitation and Sports Medicine* (1st ed.), Williams and Wilkins, ISBN 978-0683050264, London.
- Lukács, M., Vécsei, L., & Beniczky, S. (2009). Fibre density of the motor units recruited at high and low force output. *Muscle Nerve*, Vol. 40, No. 1, pp. 112-114.
- McComas, AJ., Fawcett, PR., Campbell, MJ., & Sica, RE. (1971). Electrophysiological estimation of the number of motor units within a human muscle. *J Neurol Neurosurg Psychiatry*, Vol. 34, No. 2, pp. 121-131.
- Miller-Larsson, A. (1980). A model of spatial distribution of muscle fibres of a motor unit in normal human limb muscles. *Electromyogr Clin Neurophysiol*, Vol. 20, No. 4-5, pp. 281-298.
- Monti, RJ., Roy, RR., & Edgerton, VR. (2001). Role of motor unit structure in defining function. *Muscle Nerve*, Vol. 24, No. 7, pp. 848-866.
- Nandedkar, SD., Barkhaus, PE., Sanders, DB., & Stålberg, EV. (1988a). Analysis of amplitude and area of concentric needle EMG motor unit action potentials. *Electroencephalogr Clin Neurophysiol*, Vol. 69, No. 6, pp. 561-567.
- Nandedkar, SD., Sanders, DB., Stålberg, EV., & Andreassen, S. (1988b). Simulation of concentric needle EMG motor unit action potentials. *Muscle Nerve*, Vol. 11, No. 2, pp. 151-159.
- Nandedkar, SD., & Stålberg, E. (1983a). Simulation of single muscle fibre action potentials. *Med Biol Eng Comput*, Vol. 21, No. 2, pp. 158-165.
- Nandedkar, SD., & Stålberg, E. (1983b). Simulation of macro EMG motor unit potentials. *Electroencephalogr Clin Neurophysiol*, Vol. 56, No. 1, pp. 52-62.
- Navallas, J., & Stålberg, E. (2009). Studying motor end-plate topography by means of scanning electromyography. *Clin Neurophysiol*, Vol. 120, No. 7, pp. 1335-1341.
- Pfeiffer, G., & Friede, RL. (1985). The localization of axon branchings in two muscle nerves of the rat. A contribution to motor unit topography. *Anat Embryol (Berl)*, Vol. 172, No. 2, pp. 177-182.
- Pfeiffer, G., & Kunze, K. (1992). Turn and phase counts of individual motor unit potentials: correlation and reliability. *Electroencephalogr Clin Neurophysiol*. Vol. 85, No. 3, pp. 161-165.
- Rafuse, VF., & Gordon, T. (1996). Self-reinnervated cat medial gastrocnemius muscles. II. analysis of the mechanisms and significance of fiber type grouping in reinnervated muscles. *J Neurophysiol*, Vol. 75, No. 1, pp. 282-297.
- Roeleveld, K., Stegeman, DF., Vingerhoets, HM., & Van Oosterom, A. (1997a). Motor unit potential contribution to surface electromyography. *Acta Physiol Scand*, Vol. 160, No. 2, pp. 175-183.
- Roeleveld, K., Stegeman, DF., Vingerhoets, HM., & Van Oosterom, A. (1997b). The motor unit potential distribution over the skin surface and its use in estimating the motor unit location. *Acta Physiol Scand*, Vol. 161, No. 4, pp. 465-472.

- Roy, RR., Garfinkel, A., Ounjian, M., Payne, J., Hirahara, A., Hsu, E., & Edgerton, VR. (1995). Three-dimensional structure of cat tibialis anterior motor units. *Muscle Nerve*, Vol. 18, No. 10, pp. 1187-1195.
- Schwartz, MS., Stålberg, E., Schiller, HH., & Thiele, B. (1976). The reinnervated motor unit in man. A single fibre EMG multielectrode investigation. *J Neurol Sci*, Vol. 27, No. 3, pp. 303-312.
- Stålberg, E. (1966). Propagation velocity in human muscle fibers in situ. *Acta Physiol Scand*, Suppl. 287, pp. 1-112.
- Stålberg, E. (1980). Macro EMG, a new recording technique. *J Neurol Neurosurg Psychiatry*, Vol. 43, No. 6, pp. 475-482.
- Stålberg, E. (1986). Single fibre EMG, macro EMG, and scanning EMG. New ways of looking at the motor unit. *CRC Crit Rev Clin Neurobiol*, Vol. 2, No. 2, pp. 125-167.
- Stålberg, E., & Antoni, L. (1980). Electrophysiological cross section of the motor unit. *J Neurol Neurosurg Psychiatry*, Vol. 43, No. 6, pp. 469-474.
- Stålberg, E., & Dioszeghy, P. (1991). Scanning EMG in normal muscle and in neuromuscular disorders. *Electroencephalogr Clin Neurophysiol*, Vol. 81, No. 6, pp. 403-416.
- Stålberg, E., & Eriksson, PO. (1987). A scanning electromyographic study of the topography of human masseter single motor units. *Arch Oral Biol*, Vol. 32, No. 11, pp. 793-797.
- Stålberg, E., & Fawcett, PR. (1982). Macro EMG in healthy subjects of different ages. *J Neurol Neurosurg Psychiatry*, Vol. 45, No. 10, pp. 870-878.
- Stålberg, E., & Karlsson, L. (2001). Simulation of the normal concentric needle electromyogram by using a muscle model. *Clin Neurophysiol*, Vol. 112, No. 3, pp. 464-471.
- Stålberg, E., & Sanders, DB. (1984). The motor unit in ALS studied with different neurophysiological techniques, In: *Research Progress in Motor Neurone Disease*, pp. 105-122, FC Rose (Ed), Pitman Books, London.
- Stålberg, E., Schwartz, MS., Thiele, B., & Schiller, HH. (1976). The normal motor unit in man. A single fibre EMG multielectrode investigation. *J Neurol Sci*, Vol. 27, No. 3, pp. 291-301.
- Sonoo, M., & Stålberg, E. (1993). The ability of MUP parameters to discriminate between normal and neurogenic MUPs in concentric EMG: analysis of the MUP "thickness" and the proposal of "size index". *Electroencephalogr Clin Neurophysiol*, Vol. 89, No. 5, pp. 291-303.
- Tonndorf, ML., & Hannam, AG. (1994). Motor unit territory in relation to tendons in the human masseter muscle. *Muscle Nerve*, Vol. 17, No. 4, pp. 436-443.
- Venema, HW. (1994). Motor unit innervation patterns and fiber type grouping. *Muscle Nerve*, Vol. 17, No. 3, pp. 360-362.
- Weijs, WA., Jüch, PJ., Kwa, SH., & Korfage, JA. (1993). Motor unit territories and fiber types in rabbit masseter muscle. *J Dent Res*, Vol. 72, No. 11, pp. 1491-1498.
- Willison, RG. (1964). Analysis of electrical activity in healthy and dystrophic muscle in man. *J Neurol Neurosurg Psychiatry*, Vol. 27, No. 5, pp. 386-394.
- Willison, RG. (1980). Arrangement of muscle fibers of a single motor unit in mammalian muscles. *Muscle Nerve*, Vol. 3, No. 4, pp. 360-361.
- Zalewska, E., & Hausmanowa-Petrusewicz, I. (1995). Evaluation of MUAP shape irregularity--a new concept of quantification. *IEEE Trans Biomed Eng*, Vol. 42, No. 6, pp. 616-620.
- Zalewska, E., Husmanova-Petrusewicz, I., & Stålberg, E. (2004). Modeling studies on irregular motor unit potentials. *Clin Neurophysiol*, Vol. 115, No. 1, pp. 543-556.

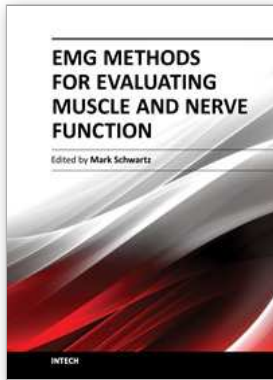

EMG Methods for Evaluating Muscle and Nerve Function

Edited by Mr. Mark Schwartz

ISBN 978-953-307-793-2

Hard cover, 532 pages

Publisher InTech

Published online 11, January, 2012

Published in print edition January, 2012

This first of two volumes on EMG (Electromyography) covers a wide range of subjects, from Principles and Methods, Signal Processing, Diagnostics, Evoked Potentials, to EMG in combination with other technologies and New Frontiers in Research and Technology. The authors vary in their approach to their subjects, from reviews of the field, to experimental studies with exciting new findings. The authors review the literature related to the use of surface electromyography (SEMG) parameters for measuring muscle function and fatigue to the limitations of different analysis and processing techniques. The final section on new frontiers in research and technology describes new applications where electromyography is employed as a means for humans to control electromechanical systems, water surface electromyography, scanning electromyography, EMG measures in orthodontic appliances, and in the ophthalmological field. These original approaches to the use of EMG measurement provide a bridge to the second volume on clinical applications of EMG.

How to reference

In order to correctly reference this scholarly work, feel free to copy and paste the following:

Javier Navallas, Javier Rodríguez and Erik Stålberg (2012). Scanning Electromyography, EMG Methods for Evaluating Muscle and Nerve Function, Mr. Mark Schwartz (Ed.), ISBN: 978-953-307-793-2, InTech, Available from: <http://www.intechopen.com/books/emg-methods-for-evaluating-muscle-and-nerve-function/scanning-electromyography>

INTECH
open science | open minds

InTech Europe

University Campus STeP Ri
Slavka Krautzeka 83/A
51000 Rijeka, Croatia
Phone: +385 (51) 770 447
Fax: +385 (51) 686 166
www.intechopen.com

InTech China

Unit 405, Office Block, Hotel Equatorial Shanghai
No.65, Yan An Road (West), Shanghai, 200040, China
中国上海市延安西路65号上海国际贵都大饭店办公楼405单元
Phone: +86-21-62489820
Fax: +86-21-62489821

© 2012 The Author(s). Licensee IntechOpen. This is an open access article distributed under the terms of the [Creative Commons Attribution 3.0 License](#), which permits unrestricted use, distribution, and reproduction in any medium, provided the original work is properly cited.