

# ESCUELA TÉCNICA SUPERIOR DE INGENIEROS INDUSTRIALES Y DE TELECOMUNICACIÓN

Titulación :

INGENIERO TÉCNICO INDUSTRIAL MECÁNICO

Título del proyecto:

JUSTIFICATION OF THE PANTONE SYSTEM INTEREST

Taybo Barrientos Perez de Landazabal

Pablo Sanchís Gúrpide

Pamplona, 28 julio 2009

---

# Author's Declaration

---

## Statement 1

This work has not previously been presented in any form to Glyndŵr University or at any other institutional body whether for assessment or for any other purposes. Save for any express acknowledgements, references, and/or bibliographies cited in the work, I confirm that the intellectual content of the work is the result of my own efforts and no other person.

## Statement 2

It is acknowledged that the author of this work shall own the copyright. However, by submitting this copyright work for assessment, the author grants to the University a perpetual royalty-free license to do all or any of those things referred to in section 16(I) of the copyright, designs, and patents act 1988 (viz: to copy work; to issue copies to the public; to perform or show or play the work in public, to broadcast the work or make an adaptation of the work).

Signed: \_\_\_\_\_.

Date: \_\_\_\_\_.

## ABSTRACT

This project is a scientific research in which the Pantone System is analyzed and described how it works theoretically in detail part by part. The background of this system's theory is widely reviewed, previous authors, theoretical concepts and Pantone's history. The real advantages and disadvantages of the Pantone System are considered, under deep and thorough analysis, concluding the final balance to be positive. And finally future actions are suggested for further studies.

## ACKNOWLEDGEMENTS

First of all I would like to express my gratitude to Glyndwr University, including all the staff, for bringing me the opportunity of studying this year Performance Car Technology. A degree that would have wanted to study since the first year, but it is only available in Great Britain. I would recommend it to anyone who is an enthusiast of automotive or race cars and wants to grow up his technical knowledge about the subject.

Secondly I would like to thank you all the people who has make possible this year for me, my Parents for supporting and holding me all the time, my Spanish coordinator in my university Dr. Pablo Sanchis Gulpide, Sinje and Karl from Formula Ford for teaching me some of his great experience about motorsport, Jose Landazabal because without him I would have hated engineering.

Finally, just as important as all of them, my teacher and supervisor, Olivier Durieux.

## TABLE OF CONTENTS

1. INTRODUCTION	1
2. AIM	3
3. REVIEW OF LITERATURE	4
3.1 Research /Background	4
3.1.1 Arturo Estévez Varela	4
History	4
Chemical additive of the invention	6
Chemistry of the hydrogen generator	7
3.1.2 Stanley Meyer	7
Description	7
3.1.3 Jean Chambrin	8
Description	8
3.1.4 Paul Pantone	9
Description	10
3.2 Theoretical Concepts	13
3.2.1 Internal Combustion engines Concepts	13
Ideal Otto cycle	13
Volumetric Efficiency	17
Thermal and Mechanical Losses	21

Air-Fuel ratio and Fuel-Air ratio	23
Knocking	24
Ideal Otto cycle VS. Real Otto cycle	26
4. METHODOLOGY	28
4.1 Software	28
4.2 Hardware	29
5. RESULTS AND DISCUSSION	30
5.1 Paul Pantone' System	30
5.1.1 Description of the Pantone System	30
Parts of the System	30
Description of the System	31
5.1.2 Fund. of the System's Reactor	33
How the reactor works	33
Electrification:	34
Operation mode	35
5.1.3 Components and Materials of the Pantone System	35
List of Components	35
5.1.4 Results	37
Effects in the engine	37

Otto cycle changed-	
-due to the implementation of Pantone System	38
Balance of the system	40
5.2 Arturo Estévez Varela	40
5.2.1 Discussion	40
5.3 Electrolysis's energy	41
5.4 Objectives Achieved	42
5.5 Discussion	42
6. CONLCLUSIONS	44
7. RECOMENDATIONS	45
8. REFERENCES/BIBLIOGRAPHY	46

## 1. INTRODUCTION

Nowadays with the automobile industry and energetic crisis, and the need of reducing the pollutant emissions to prevent the global warming, new ways of making engines more environmentally friendly are being developed by the big car manufacturer's companies. Ecology is needed.

In this context such a system like Pantone's would be a big first step in the way to cut down the dependency of automotive on petrol. This report shows the results of the work that have been done about the Pantone System

The Pantone System theory was invented by Paul Pantone in United States in the 80's it is one his hundreds of inventions. There is a patent, "US005794601A1" for a 'Fuel Pretreater Apparatus and Method'. The system it is a type of **E.H.U.D** (Exhaust Heat Utilisation Device). It uses the **GEET** technology (Magnetic Plasma Fuel Reactor Electrode). Which it claims that after a warm-up phase, about 20 minutes, gradually reduces the amount of fuel and starts to introduce water. It could be possible to run an engine with a mixture of fuel and water around 20%. With the appropriate modifications in the intake and exhaust manifolds to fit the system there is a reduction of the fuel consumption and emissions.

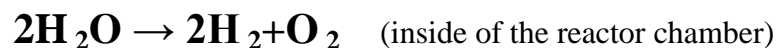

Inside of the reactor the water steam is dissociated by plasma into hydrogen and oxygen. So what is used for running the engine is not water, is hydrogen, oxygen and fuel. And there is a problem involved with using hydrogen inside the combustion chamber. The hydrogen does not produce an inflammation in inside the cylinder; it produces an explosion which can lead into knocking, what is very harmful for an internal combustion engine, reducing its life. But can be solved, or at least minimized.



### 1.1 Timeline:

This is the timeline graphic (see Fig. 1.1) followed since the project started to be developed. It was carefully thought and planned, considering the different load of work of each part, and can be adapted depending on how the project was being carried out.

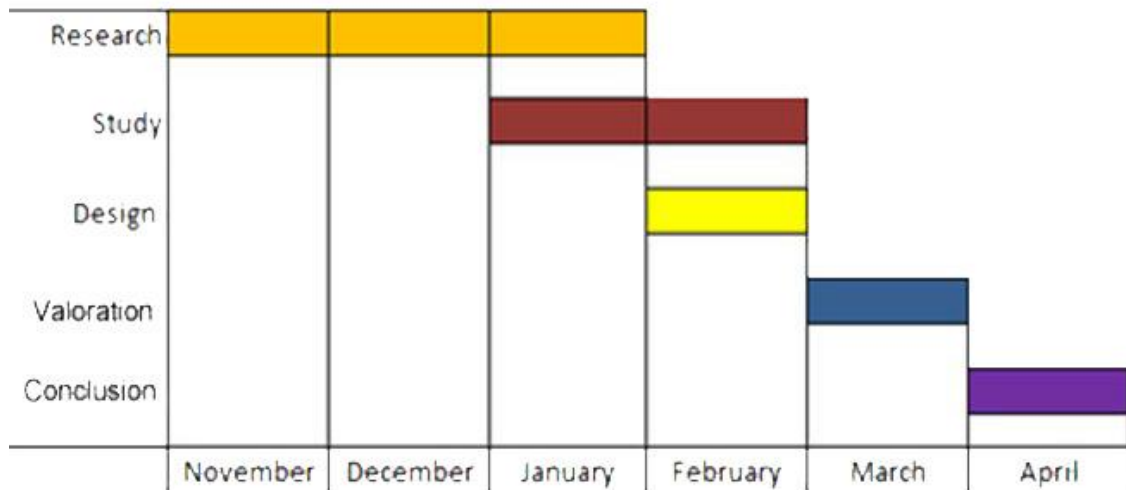

Figure 1.1 Timeline

## 2. AIMS OF THE PROJECT

The question is why Pantone's Theory has not been deeply studied before? Although it was developed long time ago, in the 80's (patented in 1998).

After the formulation of this sentence, the aim of this project is, after consideration and contrasting all the data of the research, all the findings and all of the bibliography; to justify (or not), to give a verdict about the Pantone technology. To have an answer about if it works, if so, what is the efficiency of the system, if it can be efficiency enough for developing into mass production.

What is wanted to achieve with this project is to obtain a result that will come through rigorous analysis. Because there is lot of people, inventors, retired people, rich-full of free time people, and even some engineers that tried to, and some, have developed new ways to propel automobiles or generate electricity with engines, using alternative technologies in some cases or theories in others. These technologies are claimed to be more efficient than all the other ones that have been proved through decades in the industry. But no one has tried to investigate these alternative technologies with the scientific rigor required to judge them if they are false or if they are true. So both parts included, accuse each other. Ones say that their new developments have been stolen by the petrol industry and the others that these developments are only a fraud.

As a result of this, investigations have been carried out on The Pantone System theory, in order to evaluate its value and interest as well as its advantages and disadvantages.

### 3. REVIEW OF LITERATURE

Through this section theoretical concepts and data of the research about the Pantone System, and other authors who have been considered to be relevant for the understanding of the project will be explained.

#### 3.1 Research/Background

In this subsection of the report there is expanded information about different authors a part of Paul Pantone who has invented and/or developed other technologies and devices which share some similarities with the Pantone system; all of them have tried to use alternative ways of energy different to oil, mainly hydrogen, to run internal combustion engines. But differ in the way to obtain this product.

##### 3.1.1 Arturo Estevez Varela

Thirty years ago an inventor from Extremadura (Spain), Arturo Estevez Varela, presented for the first time to the public an engine that could run with water and was able to work in a vehicle. Many people were interested in it, but unbelievably it never was commercialized. He invented a way to run an engine with water, adding some chemical additive; it is very likely to be Boron, which in contact with water releases great amount of energy and hydrogen.

#### History:

In May 1979, a Spanish newspaper called EL PAIS published a short note: *“Arturo Estevez, the inventor of the hydrogen generator, claims that he can prove that his invention, which is 50,000 GBP, produces 350.000 kilograms of hydrogen. That is an energetic power of 1,400.000 liters of petrol. Now the chairman of the Centre of Study of Energy of Madrid is interested in it, who has asked for further information about the generator”*. That is what the news said. There are also two photographs in the photographic archive of the E.F.E. agency, and a note in which can be read: *“The inventor Arturo Estevez from Extremadura, settled in Seville, testing during two hours in front numerous witnesses, a motorcycle propelled by a hydrogen engine, known as water engine, in the main square of Seville”*. Those photographs were taken on 1 July

1970, nearly ten years before any new about this device appeared. Furthermore in the 70's this inventor climbed in direct gear 1511 m. of height of a hill near Madrid with a modified Renault 8. The carburetor of that car and the fuel tank had been replaced to adapt the hydrogen generator. The cost of that modification 30 years ago was of 30GBP.



**Figure 2.1** The modified engine that Arturo Estevez (left centred in suit and tie) started for the first time. (HOY.es)

The clue is that, after infinite public tests proving that his Hydrogen Generator worked, the General F. Franco asked for a meeting with him and also for a feasibility report of the invention to the School of Engineers. However, the report certificated the invention as “non feasible”. Even more seems that the Govern bought the patent and made it disappear due to the pressure of the Oil Companies.

Nowadays there are no evidences of any of the machines, prototypes neither plans or sketches of the system that Arturo Estevez manufactured. It is very likely that all of them were forgotten and destroyed by the pass of time. His family says that “*only a couple of plans and notary documents survived, but now a private owner has them*”.

### Chemical additive of Arturo Estevez Valera's invention:

The inventor never revealed what kind of additive used to make the water combust and run in an engine. The project, in which he spent more than 50,000GBP of that era, needed some product to react with water and liberate the enough energy to run an internal combustion engine, smoothly, constantly and with the enough power to propel a vehicle at a reasonable speed in any kind of road. He travelled more than 30,000 kilometres round Europe searching that precious product.

Over time has become known that it could have been **Boron**, as it has already been said. This element exists in the nature combined with other materials or in crystalline form. It is mainly extracted from arid areas of Turkey and U.S.A. But it also can be found in some parts of <sup>ii</sup>Argentina, Chile, Russia, China and Peru. One of the main properties of this product is that liberates hydrogen in contact with water. This reaction is being studied nowadays by the Weizmann Institute of Science, Israel, in a project of Storage and Transport of Solar Energy. This institution is developing the interaction between water and born which is followed by a direct consequence: "reaction-movement".

It seems that Arturo Estevez concluded that: with 45 litres of water reacts with 8 kilograms of reagent (boron) obtained 5 kilograms of hydrogen, which means around 40 litres of petrol. This will lead to a range of about 500 kilometres. In other words, with 2.5 litres of water and 1 kilogram of "secret product" 3 cubic metres of hydrogen were obtained. This is as much energy as 9 litres of petrol.

However the price of that fuel was another issue. The price of born is 4.2 €/gr. So filling a tank with 8 kilograms would cost 33,000 GBP. But using recycled boron which is 1.6 €/gr., or producing it in mass production will drop its cost.

### Chemistry of Arturo Estevez Valera's hydrogen generator:

Victor Acosta, Physics Professor of Base College of Madrid and the Weizmann Institute of Israel has reached the same conclusion through different ways. It is very likely and scientific proved that, Arturo Estevez Varela could have used boron, which produces the next exothermic reaction:



This reaction means that, water and boron, reacts and the result is boric anhydride. In this compound, the boron takes the oxygen from the water molecule and in this process heat and hydrogen is liberated. If the obtained hydrogen in this reaction, is introduced and compressed inside the combustion chamber of an internal combustion engine, can be ignited by the spark of the spark plug. This will cause its inflammation and the power enough to move the piston rod and crankshaft. Final result: motion. (This can be seen in the next chemical reaction).



The consumed hydrogen is recovered to fill the water tank, and the boric oxide, the only residue, is sent to recycle and then obtained more boron.

#### 3.1.2 Stanley Meyer<sup>iii</sup>

This inventor developed a machine, "*The Water Fuel Cell*", that claims to produce hydrogen from water dissociation using three times less energy than the traditional electrolysis.

#### Description:

The device uses a different process from electrolysis. In the fuel cell electrons are restricted; the water molecule undergoes a lot more stress, and an added sequence of events producing much higher energy efficiency than electrolysis.

He invented a device to adapt it to a petrol engine of a road car to run this engine with only water. He claimed that with his water fuel cell invention adapted to the engine, the car only needs water to run, and with a very good fuel mileage. Meyer claimed that: *“<sup>iv</sup>he could run a 1.6 liter Volkswagen Dune Buggy on water instead of gasoline.*

*He replaced the spark plugs with injectors to spray a fine mist into the engine cylinders, which he claimed were electrified at a resonant frequency. The fuel cell would split water into hydrogen and oxygen gas, which would combust back into water vapor in a conventional hydrogen engine to produce net energy. Estimates made showed that only 22 US gallons (83 L) of water were required to travel from one US coast to the other. Meyer also demonstrated his vehicle for his city's local news station Action 6 News”.*

### 3.1.3 Jean Chambrin<sup>v</sup>

He was a French mechanical engineer and inventor that developed a Water-Alcohol Motor in Paris, 25 February 1975. The inventor claimed that his motor's design could be mass-produced at a fraction of the cost of present engines, but it was not further developed. There are two patents about his invention: WO8204096 and WO8203249.

#### **Description:**

The device is described as: *“An apparatus which permits the conditioning of the water and fuel mixture, limited to pure water, causing an electromagnetic reaction capable of producing hydrogen and a plasmatic state of matter, to be used in engines and heating systems. It concerns the use of electromagnetic energy obtained primarily from a combustible and then from water and combustible mixture and, finally, from pure water, under the form of thermo magnetic energy (burners, boilers, etc.) or propelling energy (internal-combustion engine or reaction engine).*

*The decomposition of the water into its basic elements (oxygen and hydrogen) is feasible, either by electrolytic or electromagnetic processes. Both processes demand a*

*considerable quantity of electrolytic or electromagnetic energy, stored oxygen and hydrogen, carriage of these elements and their delayed application.*

*The Reactor, as it is suggested to be used, is not subject to such inconveniences since electromagnetic decomposition of the water can be quickly and directly obtained, as far as it is used. The necessary and indispensable calorific energy to the internal electromagnetic reaction is ensured within the cycle confined to the right application which eliminates the discriminating inconveniences and risks inherent to the usual processes.*

*Another advantage of the conceived process is to produce energy in a much more economical way.*

*The described reactor converts the mixture before its introduction in the inlet manifold of the engine. This mixture consists of water and fuel (gasoline, diesel, alcohol, ammonia, etc.) limited to pure water, in view of its use in an engine or heating system“.*

### **3.1.4 Paul Pantone**

The system processor Multi Fuel G.E.E.T. called Pantone system is named because its inventor, Paul Pantone. An American electrical engineer who focused in electronics looking for new areas of research, he patented bold PMC-G.E.E.T. in 1998 after working 20 years and more than four hundred tests with the help of his wife Molly, the patent number is (US005794601A1). He then decided to make available to the general public set of carburetors for lawnmowers and small engines.

Meanwhile, Paul Pantone and his wife founded the company G.E.E.T. (Global Environmental Energy Technology) in 1994 which manufactures modified generators and made all sorts of technical improvements on the Pantone system.



**Description:**

The Pantone Theory follows the next diagram (see Fig 2.2):

vi

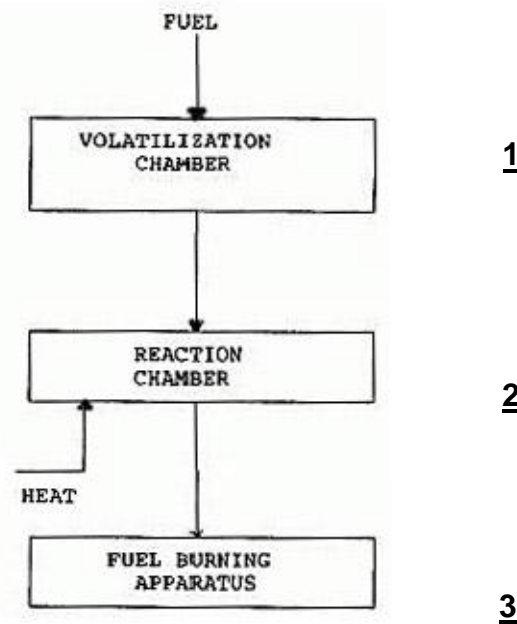

Figure 2.2 Pantone System Flow Diagram

First the fuel goes into the Volatilization Chamber (see 1 Fig. 2.3), where it is turned to steam because of the exhaust gasses heat. Then the mixture of fuel, air and water steam goes into the Reaction Chamber (see 2 Fig. 2.3). This is the main part of the system (Fig. 2.4) where the reaction that dissociates the water into hydrogen and oxygen occurs because of the plasma generated there due to the vibration of the electrode, the magnetic field generated inside, and the gradient of intake and exhaust flow velocity.

Finally the mixture of gasses is burnt in the engine's cylinder chamber (see 3 Fig. 2.3). As in any conventional petrol engine, but with the difference that here some hydrogen is burnt. But burning hydrogen means a drastic increase of pressure rather than an inflammation, more similar to detonation, with the problems that this means.

The result of the implementation of this system in to an engine, petrol or diesel, should derive into a reduction of fuel consumption and a reduction of pollutant emissions, without a loss of power.

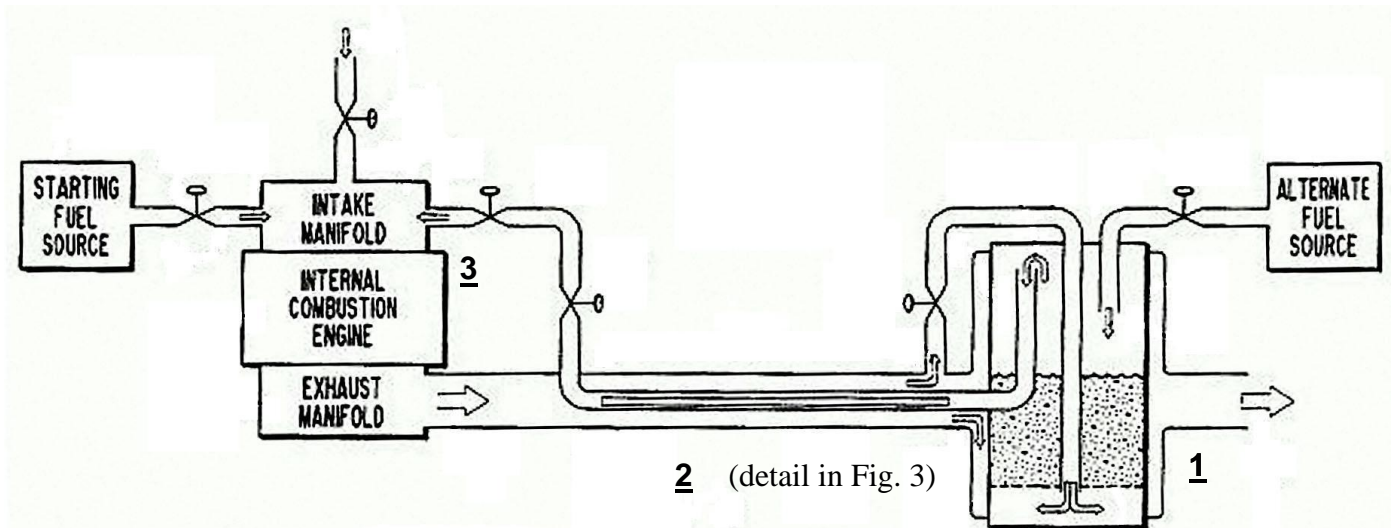

Figure 1.3 Pantone Engine Schematic Flow Diagram

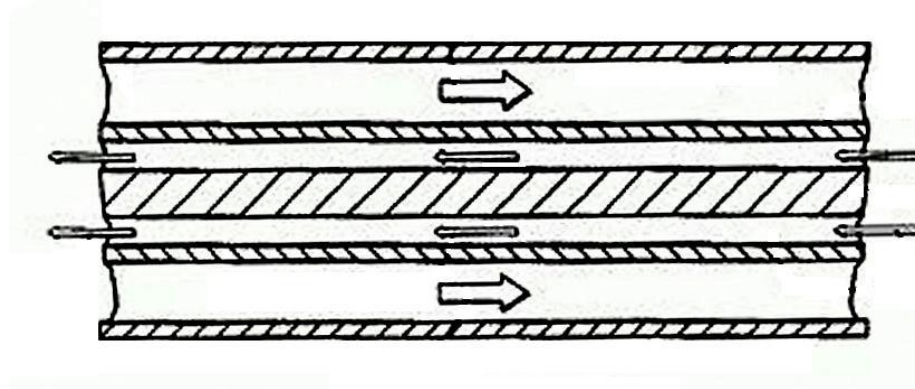

Figure 2.4 Pantone Engine Reaction Chamber Flow Diagram (detail)

Here is explained in detail how works the internal part of the **electrode** of the system (see Fig. 2.5<sup>vii</sup>). This detail remains inside the exhaust pipe. The intake pipe is

made of a ferromagnetic material, as well as the rod inside of it. Vacuum is applied to the top end in the figure, usually with the intake of the engine. The entire electrode pipe is surrounded by the heat of the exhaust gasses.

At the middle part of the figure, which corresponds to the same part as in the entire pipe, magnetically compressed vapours develop great temperature creating a hot spot; “Plasma Pinch”. This hot spot is said to be discovered by Christophe Martz<sup>viii</sup> on the otherwise end of the pipe during his university research.

First the vapours become ionized by the same processes that ionize thunderclouds. Then the initial remnant magnetic field deflects the ionized vapours into a vortex. Finally the vortexing ionized vapours create their own magnetic field that adds to the original field making it much more intense. This is claimed to be said by Naresh Vasant.

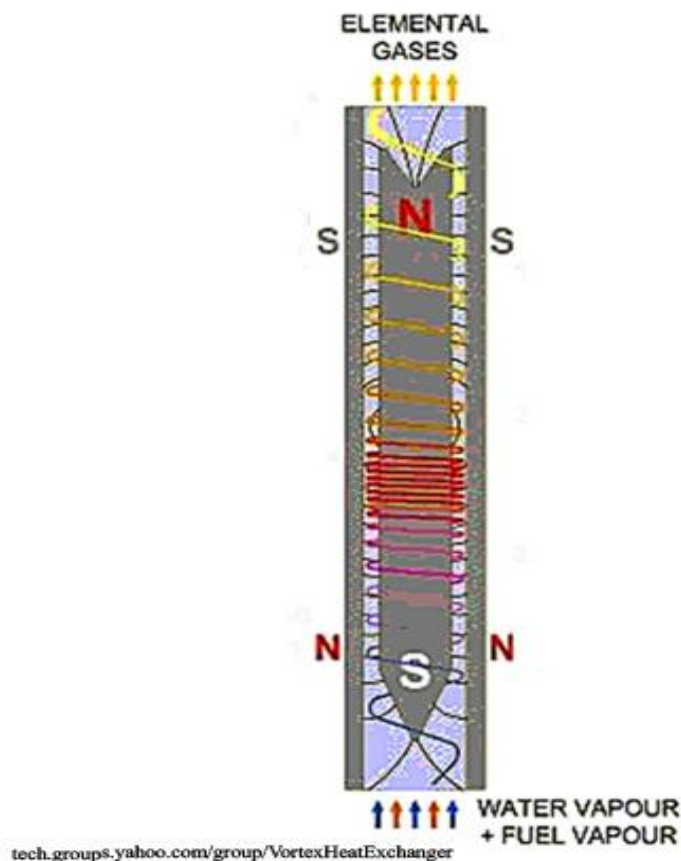

Figure 2.5 Vortex Heat Exchanger, (Electrode Detail)

### 3.2 Theoretical Concepts:

For the development of this project some theoretical knowledge is required which is detailed below.

#### 3.2.1 Internal Combustion engines Concepts<sup>ix</sup>:

##### Ideal Otto cycle:

In a conventional petrol engine running in Otto cycle, the four stroke cycle is developed, as it can be seen in Fig. 2.6<sup>x</sup>, in that figure also appears the ideal P-V diagram of the Otto cycle.

These are the four strokes that with two turns of the crankshaft make one cycle:

- Firstly the **intake stroke**, (see **a** Fig. 2.6) the piston moves from TC to BC, with the inlet valve open and the exhaust valve closed, filling the cylinder with fresh mixture. The crankshaft turns half turn.
- Secondly, the **compression stroke**, (see **b** Fig. 2.6) both valves are closed and the piston moves from BC to TC and the mixture inside the cylinder is compressed to a small fraction of its initial volume. Toward the end of the compression stroke, the combustion is initiated by the spark plug and the cylinder pressure rises rapidly. The crankshaft turns half turn.
- Thirdly the **power stroke**, or **expansion stroke**, (see **c** Fig. 2.6) starts with the piston at TC and ends at BC as the high-temperature, high-pressure, gases push the piston down and force the crankshaft to rotate. As the piston approaches BC the exhaust valve opens to initiate the exhaust process and drop the cylinder pressure to close to the exhaust pressure. The crankshaft turns half turn.
- Finally the fourth stroke of the cycle, **exhaust stroke** (see **d** Fig. 2.6). The piston moves from BC to TC and the remaining burned gases exit the cylinder. First, because the cylinder pressure may be substantially higher than the exhaust pressure. Second, the burned gases are swept out by the piston as it moves toward TC. Finally, the piston approaches TC, the inlet valve opens, just after TC the exhaust valve closes and the cycle starts again. The crankshaft turns half turn.

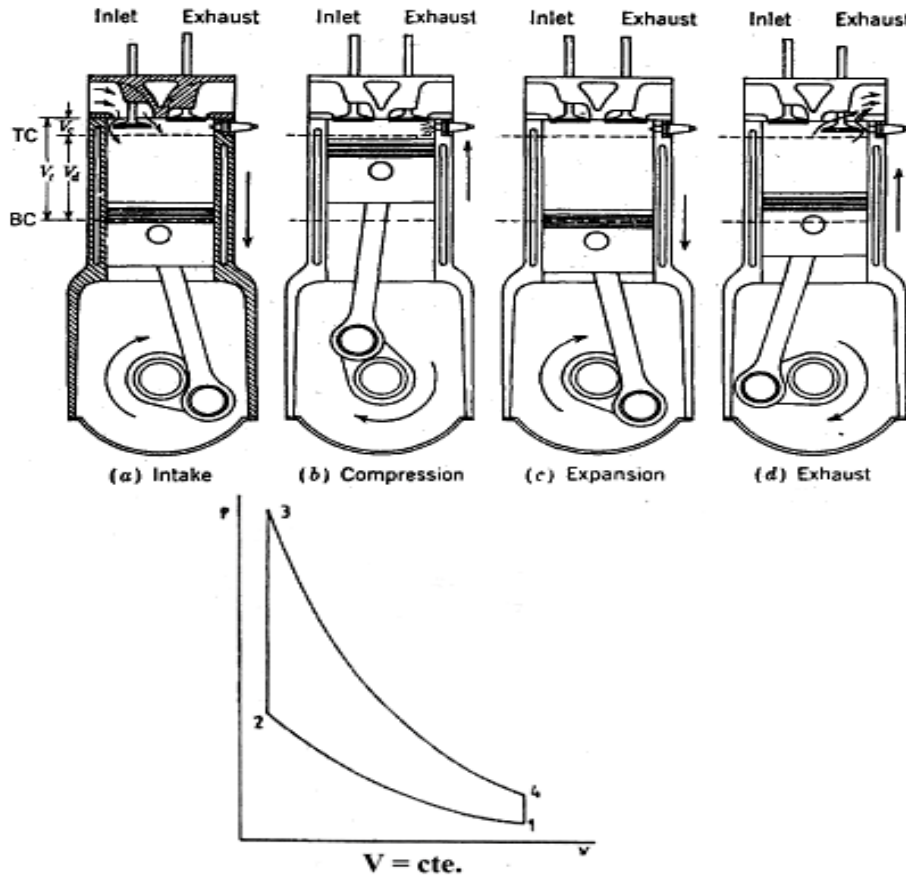

Figure 2.6 The four-stroke operating cycle.

There are some thermodynamic **equations** that have to be followed in the Otto cycle.

- The **energy transferred** in the Otto cycle can be obtained through the following thermodynamic equations (see also Fig 2.7):

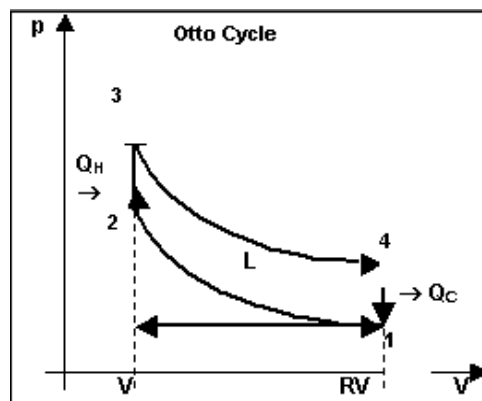

Figure 2.7 Otto Cycle

Energy absorbed:  $|Q_h| = \Delta U_{2 \rightarrow 3} = n c_v (T_3 - T_2)$

Energy transferred:  $|Q_c| = \Delta U_{4 \rightarrow 1} = n c_v (T_4 - T_1)$

- Some **parameters** are going to be determined in the cycle:

Volumetric Compression Ratio:  $r = \frac{V_D + V_C}{V_C} = \frac{V_1}{V_2} = \frac{v_1}{v_2}$

Pressures Relation:  $\alpha = \frac{p_3}{p_2}$

Volumes Relation:  $\beta = \frac{V_{3A}}{V_3} = \frac{v_{3A}}{v_3}$

Where:

$V_C$  and  $V_D$  are the volume of the combustion chamber and the unit capacity of each cylinder of the engine.

$V_1$ ,  $V_2$ ,  $V_3$ , and  $V_{3A}$  are the volumes at the points 1, 2, 3 and 3A of the thermodynamic cycle respectively.

$v_1, v_2, v_3$ , and  $v_{3a}$  are the specific volumes at the points 1, 2, 3 and 3A.

- The specific net work of the cycle will be:

$$w_N = q_1 - |q_2|$$

$$q_1 = q_{2,3} + q_{3,3A}$$

$$|q_2| = |q_{4,1}|$$

Where  $q_1$  is energy (heat) given in the cycle,  $|q_2|$  the energy transferred to the exterior.

- Considering all the process of the cycle, the values of the parameters previously defined and If the fluid that evolutions is considered as a perfect gas, can be proven that:

$$q_1 = c_v T_1 r^{\gamma-1} [\alpha - 1 + \gamma \alpha (\beta - 1)]$$

$$|q_2| = c_v T_1 (\alpha \beta^\gamma - 1)$$

Where  $c_v$  is the specific heat at constant volume of the air, and  $\gamma$  is the adiabatic coefficient of the air. As a result:

$$w_N = c_v T_1 \left\{ r^{\gamma-1} [\alpha - 1 + \gamma \alpha (\beta - 1)] - (\alpha \beta^\gamma - 1) \right\}$$

- The thermal efficiency of the cycle will be:

$$\eta_t = \frac{w_N}{q_1} = 1 - \frac{|q_2|}{q_1}$$

Substituting the values is obtained:

$$\eta_t = 1 - \frac{1}{r^{\gamma-1}} \frac{\alpha \beta^\gamma - 1}{\alpha - 1 + \gamma \alpha (\beta - 1)}$$

As  $\beta=1$  in the Otto cycle, the result is:

$$w_N = c_v T_1 (r^{\gamma-1} - 1) (\alpha - 1)$$

$$\eta_t = 1 - \frac{1}{r^{\gamma-1}}$$

The **efficiency** of the **cycle** is:

$$\eta_t = 1 - \frac{1}{r^{\gamma-1}}$$

Where:

$\gamma$ : Adiabatic coefficient (1.4 for Air)

$r$ : Compression ratio ( $V_{max}/V_{min}$ )

These thermodynamic equations have to be satisfied by the Pantone Theory in order to consider its feasibility.

### Volumetric Efficiency:

The volumetric efficiency is one of the most important parameters of an engine directly involved with the amount of power and performance that can be obtained from it. Getting the maximum amount of air into the cylinder on each cycle will make maximum those parameters.

This is the relation that explains it:

*more air → more fuel can be burnt → more power developed*

It is easier to get a small volume of fuel into the cylinder than getting a large volume of air.

In an ideal engine the air mass ingested in a cycle would be equal to the density of atmospheric air multiplied by the displacement of the cylinder. But in a real engine this mass is less because of short cycle time available and flow restrictions caused by:

- Air filter
- Compressibility of air
- Carburettor (if applicable)
- Intake manifold
- Intake valves



So the volumetric efficiency is defined as:

$$\eta_v = \frac{m_a}{\rho_a V_d}$$

$$\eta_v = \frac{n\dot{m}_a}{\rho_a V_d N}$$

Where:

**$m_a$** : is the mass of air into the engine (or cylinder) for one cycle

**$\dot{m}_a$** : is the steady flow of air into the engine

**$\rho_a$** : is air density at atmospheric conditions outside the inlet manifold

**$V_d$** : is the displacement of the engine

**$N$** : is the engine speed

And the standard conditions taken by agreement to find the air density (see below de equation) unless other data is given are:

$$P_0 = 101325 \text{ Pa}$$

$$T_0 = 298\text{K} = 25 \text{ }^\circ\text{C}$$

$$\rho_a = \frac{P_0}{R T_0}$$

Where:

$P_0$  = is the pressure of surrounding air

$T_0$  = is the temperature of surrounding air

$R$  = is the gas constant for air (0.287 Kj/kg K)

If the conditions are different than the standard ones described when the situation requires it, they can be changed by the ones that have been measured in the place of the measurement.

At standard conditions, the air density is:  $\rho_a = 1.181 \text{ kg/m}^3$

- In *normal aspirated engines*, the standard conditions are the ones of the atmosphere, or the ones in the inlet manifold, taking in consideration the air filter and the carburettor or similar devices.
- In *turbocharged and supercharged engines*, the reference conditions must be taken after the compressor, in other way a volumetric efficiency greater than 1 would be obtained. What is not possible.

Typical values for volumetric efficiency are:

- At WOT 75 – 90 %
- Goes down to much lower values when the butterfly valve of the throttle body is nearly closed. There is a direct relation with pumping losses (see pumping losses)

As a main result of the last consideration, restricting the air flow into an engine is the primary source of power control for a spark ignition internal combustion engine.

The most influential factors involved in the volumetric efficiency are:

- *Engine speed:* with the increase of the engine speed the volumetric efficiency increase a little but later it decreases due to frictional losses proportional to the squared of speed, and also because of the compressibility of the fluid. This means that part of the kinetic energy of the fluid is transformed in heat because of the friction.
- *Valves:* if the engine usually runs at high speeds, great section valves will be required, but at low speeds the volumetric efficiency is low because of the low speed of the fluid through the big sections of the valves. But big valves can cause deformation problems and great inertias due to is big mass. So multivalve engines are manufactured to solve this problem, but suffer from low speed losses at when the engine runs at low speeds also. The other way, at low speeds the valves must have a small section.
- *Inlet manifold:* if the engine usually runs at high speeds, the conducts has to be short and wide, but at low speeds happens the same as in the previous section. However if it runs normally at low speeds, the inlet manifold's conducts have to be long and narrow. Furthermore, the manifold can be manufactured to obtain benefit for better filling of the cylinder from the resonance waves produced in the manifold because of the closing and opening valves.
- *Distribution diagram:* the best would be a full variable distribution, but it is not available yet. So it is usually optimized for a range of engine's speed, low-medium or medium-high. For low-medium speeds short lift of valves, and for medium-high speeds long lift of valves.

### Thermal and Mechanical Losses:

In this part of the theoretical concept's section some of the main losses of an engine are going to be explained.

- How is managed the energy liberated per unit of time by the fuel when the combustion occurs inside the engine. If a **thermal balance** is carried out, (see Fig. 2.8) is obtained:

$$\dot{Q}_t = \dot{Q}_N + \dot{Q}_r + \dot{Q}_{ra} + \dot{Q}_a + \dot{Q}_{res} + \dot{Q}_g$$

- $\dot{Q}_t$  Heat flow that provides the fuel when burn.
- $\dot{Q}_N$  Heat flow converted in effective power.
- $\dot{Q}_r$  Heat flow transferred to the coolant fluid.
- $\dot{Q}_{ra}$  Heat flow lost by radiation.
- $\dot{Q}_a$  Heat flow transferred to the oil.
- $\dot{Q}_{res}$  Heat flow lost due to incomplete combustion.
- $\dot{Q}_g$  Heat flow lost in the exhaust gasses.

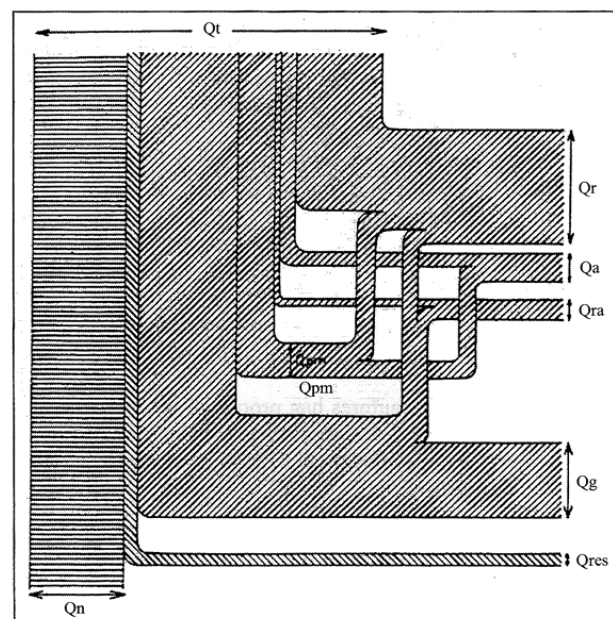

Figure 2.8 Thermal Balance

- If a balance of the released heat to the refrigerant liquid is carried out in an engine considering where it is mainly located, the next results will be obtained:

Cylinder head	Cylinder wall	Exhaust manifold	Other parts
50-60%	8-22%	16-26%	2-6%

- If a balance of the heat losses in an engine is carried out considering the different stages of the cycle is obtained:

Compression	Combustion	Power	Exhaust
1-3%	6-10%	30-50%	
50%			50%

If a fully adiabatic engine could be manufactured, only half of the heat transferred to the refrigerant could be exploited, due to the other half of the heat is used to elevate the thermal state of the exhaust gases.

**Pumping losses** are caused by the processes of inlet and exhaust in the four stroke engines. They form the negative area of the P-V real diagram of the Otto cycle, these losses depends of:

- Distribution diagram
- Existence or not of counter pressure in the exhaust pipe
- Pressure losses in the inlet manifold
- In the self ignite engines depends of the opening of the butterfly valve of the throttle body what makes go down the inlet pressure. Is one of the main causes of pumping losses.

### Air-Fuel ratio and Fuel-Air ratio:

Air-Fuel (AF) and Fuel-Air (FA) ratios describe this mix:

$$AF = \frac{m_a}{m_f} = \frac{\dot{m}_a}{\dot{m}_f}$$

$$FA = \frac{m_f}{m_a} = \frac{\dot{m}_f}{\dot{m}_a}$$

Where:

$m_a$  = mass of air (kilograms)

$m_f$  = mass of fuel (kilograms)

$\dot{m}_a$  = mass flow rate of air (kg/s)

$\dot{m}_f$  = mass flow rate of fuel (kg/s)

The stoichiometric (or ideal) air-fuel ratio (AF) for the most types of gasoline for petrol engines is very close to relation 15:1. But the combustion is normally possible between the range 6-19.

- If the air- fuel ratio is lower than 6, the mixture is too rich, too much fuel to sustain combustion.
- if the air-fuel ratio is bigger than 19, the mixture is too lean, too less fuel to sustain combustion.

The system that manage the amount of fuel fed to the manifold (injection or carburettor), must be able to regulate it properly at any time, as fast as possible and for any given airflow. This will be directly involved with the ability of the

engine to adapt to any kind of condition like acceleration, starting, cruising, deceleration and any kind of opening of the butterfly valve of the throttle. In a real engine the AF is usually between the range of 12-18.

Other aspect of this theoretical concept is the **equivalence ratio  $\phi$** , is defined as the actual ratio of fuel-air (FA) to ideal or stoichiometric fuel-air ratio (FA):

$$\phi = \frac{(\text{FA})_{\text{actual}}}{(\text{FA})_{\text{stoich}}} = \frac{(\text{AF})_{\text{stoich}}}{(\text{AF})_{\text{actual}}}$$

### Knocking:

Knocking is the self inflammation of the last unburned fraction of the mixture. Usually the mass of mixture is burnt while it is expanding, and so, compressing the mixture that's to be burnt. In some circumstances these fractions of the unburned mixture can auto ignite very quickly, producing a pressure drop inside the cylinder, causing a characteristic noise. This produces an abnormal overheating of the engine that can cause serious damage to the engine's parts. Knocking usually occurs at whole opened throttle when the engine is loaded.

Self-Ignition characteristics of fuels:

- If temperature of air-fuel mixture raises high enough, it will ignite.
  - This is the self ignition temperature (SIT)
  - Principle of internal combustion engines
  - Compression high enough to raise temperature to SIT during compression stroke
  - NOT desirable in an self ignite engine
  - Compression ratio is limited to 11:1 to avoid knock

The most influential factors involved in the knocking are:

- Octane number of the fuel, the greater the octane the less knocking
- Load of the engine, if it increases the amount of mixture increases too and leads to increasing the temperature of the last unburned fraction of mixture, increasing the knocking tendency
- Increasing ignition advance, increases strongly knocking tendency, because pressure and temperature increase a lot
- Compression ratio, it increase the knocking tendency increase too
- Place and number of spark-plugs. The spark-plugs are placed in the hottest part of the combustion chamber and also where the main part of mixture s going to be, to reduce knocking tendency.
- Combustion chamber, is desirable that the relation surface/volume as small as possible near the spark-plug to decrease the temperature of last fraction of mixture remaining without being burnt. The flame must pass through and consume all unburned gasses. Combustion chamber must be as compact as possible
- Engine size, if it increases the relative heat losses decrease, so higher temperatures are reached, increasing the knocking tendency
- Nowadays engines have knock detectors, so the E.C.U. can manage engine parameters (timing, AF mixture, etc.) to run the engine near this point, but without reaching it.
- Using rich mixtures AF lower than 6, helps to cool the cylinder and piston when the extra fuel added vaporizes in the combustion chamber.
- Other factors that can cause surface ignition resulting in knock. Hot spots on cylinder walls, deposits in combustion chamber, hot exhaust valve, hot spark-plug electrode, sharp corner in combustion chamber





- As the combustion is not adiabatic, there are important heat losses, caused by the refrigerating system.
- The fact of starting the combustion nearby the spark plug make a variety of caloric capacities related with temperature. Obtaining a mean temperature given by the thermal energy of the fuel lower than the theoretical, decreasing the efficiency.
- The combustion is always uncompleted, due to the mixture is not homogenous and the mixture near the walls is at lower temperature making difficult the combustion.
- In the expansion stroke there are important heat losses caused by the refrigerating system.
- At the end of the expansion stroke there are surface losses, exhaust losses due to the advance exhaust opening, necessary to decrease the exhaust pumping work.

## 4. METHODOLOGY

In this section is explained what tools, software or information have been used in the development of the project, and also for the manufacturing of the poster for the presentation.

### 4.1 Software

These are the different kinds of software used in the development of the project. It has been used, thermodynamics software, word processors, slide show software and image software.

#### 4.1.1 **Thermodynamic software**

In this project has been used Termograf v5.5, a Spanish thermodynamic software created by the Didactic Group of Thermal Engineering of the Zaragoza University.

This software is a great tool for engineers who have to do thermodynamic calculations. Because makes them lot of faster and accurate than using tables. What is a clear benefit for the user and the industry. At the beginning you have to choose the kind of system you are going to study, the units of it and the convention ( $\Delta U = Q + W$  or  $\Delta U = Q - W$ ). Then you can start drawing in the chosen diagram (PV, hs, Ts, PT, etc) the different transformations (adiabatic, polytropic, isobar, etc) you need to use. Or create a thermodynamic cycle and calculate its efficiency. Also you can introduce the values of the different points, or once you have made a draw introduce the values. It is very visual and since the beginning you can start to solve many problems. But if you go further it can useful for example for example for power plants calculations.

#### 4.1.2 **Word Processor**

Nowadays a computerized word processor is vital for any written document you have to handle out. Since the smallest essay to the final year project, everything has to be word processed. So for this project has been chosen Microsoft Word 2007 for all the written documents.

For the presentation's slides Microsoft PowerPoint has been chosen for being the standard worldwide used, and mainly because it has to been used before in previous presentations through the different courses of the degree.

#### **4.1.3 Image software**

For creating the poster and treating and adjusting images of the project, colors, lights, and also for creating some photographs of different parts of the system. Adobe Photoshop CS2 has been used. The main reason is its wide range of application it provides, so it is useful for anyone.

#### **4.1.4 Designing Software**

For designing some parts of the system, specially the reactor's details, and creating pictures of some parts of the Pantone System, SketchUp7 has been used. It is a free software for quick drawing sketches in 3-D. Very intuitive and easy to use. It is developed by Google, and downloading is free.

### **4.2 Hardware**

For the manufacturing of the Final Presentation's poster, different set of rulers and set square have been used in order to have clean and straight cuts in the different pictures, forms and titles of it.

For cutting the different pieces that forms it sharp blades and scissors were used, and to fix all stick glue.

## 5. RESULTS AND DISCUSSION

In this section is explained all the findings that have been done and discussed through different sections.

### 5.1 Paul Pantone' System

The fundamental of the system is based on recovering and treating the exhaust gases making them pass through the reactor where an electro-chemical-magnetic reaction occurs, and then inject them it into the engine's intake. The hot gases goes back to the inlet flow through a small annular space (created by the geometry of the reactor) and then subjected to a magnetic field oriented in the north-south reactor. It is a treatment process of the fuel plasma discharge as defined by its inventor, Paul Pantone. However it is difficult to explain scientifically the causes of this reaction. This multi-fuel processor produces a reduction of pollution emissions from exhaust gases and fuel consumption that can be about 20%.

#### 5.1.1 Description of the Pantone System

In this part of the report is going to be explained in detail how works the whole Pantone system according to the results obtained after all the research done.

#### Parts of the System:

As can be seen in Figure 5.1, the system is formed by different parts connected to the inlet and exhaust manifold which are going to be enumerated and described below:

- The *bubbler* is a reservoir where the mixture of carburant (fuel and water) is kept. Part of the exhaust gasses are re-circulated to this tank to generate turn into steam the mixture.
- Part of the *exhaust pipe* comes out from the bubbler and the rest from the reactor, both of them are connected before the *muffler*, it is common one appropriate for the type of engine used.

- The *auto-induction plasma reactor*, that contains a magnet rod and a pyrolysis chamber, it is the heart of the system. It is made up of two coaxial pipes; the exhaust pipe is the outer tube and the inlet pipe inside, finally the steel rod in the center. There must be one millimeter and a half between the steel rod and the inner tube.
- There are different valves to govern the engine, in the Figure 5.1 can be seen what would be the *throttle* in a conventional engine, in the left part of the picture “Air mixture valve” but it has to work associated with valve upside the “Auxiliary air valve”. The other valves are placed to run the engine after starting it as a conventional engine during the preheating period until the reactor is ready to work.
- The engine itself is conventional, only the timing and some anti-knocking parameters should be modified to adapt it to the Pantone System. But they are no great modifications.
- The intake and exhaust manifolds have to fit the system’s dimensions and match up with the pipes.

### **Description of the System:**

The mixture of fuel and water is vaporized in the bubbler, aspirated by the inlet pipe. It passes through different valves those regulate the engine load. Then it goes along the reactor between the small gap of the steel rod and intake pipe, heated by the hot gasses of the exhaust that are moving in the opposite direction part of them towards the atmosphere through the muffler and other in direction to the bubbler again. Along this part of the system occurs the reaction (which will be described later) that dissociates the water steam into hydrogen and oxygen.

Then the new mixture, fuel, oxygen and hydrogen goes inside the engine. Into the combustion chamber where is compressed and ignited by the spark plug transforming the chemical energy of the mixture into mechanical energy through the different parts of the engine, piston rod, crankshaft... This energy provides movement into an axle which can be used for anything.

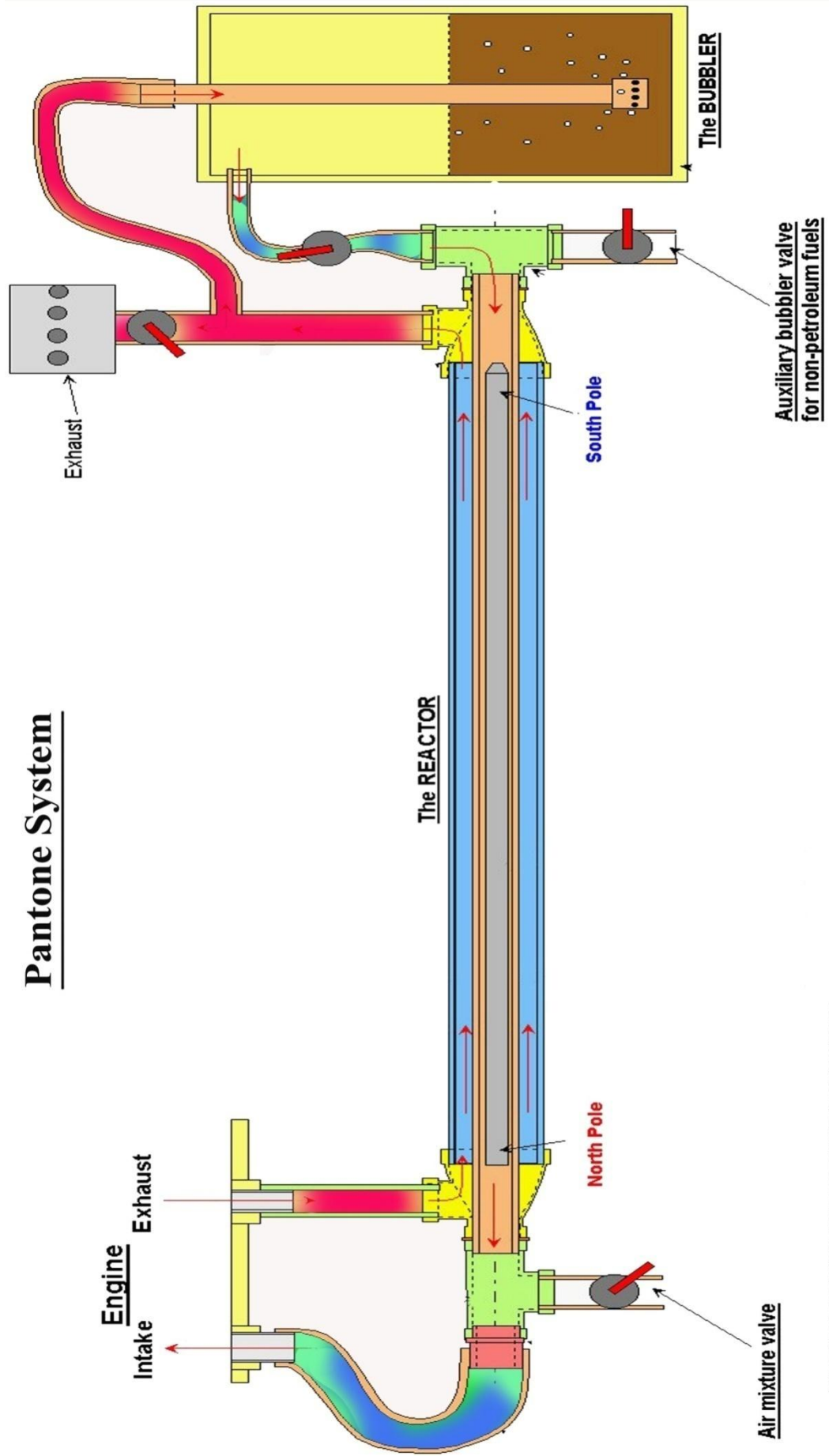

**Pantone System**

Figure 5.1 Pantone Whole System Diagram

<http://teslatech.info/ftstore/articles/geet/geet.htm>

### 5.1.2 Fundamental of the System's Reactor

In this subheading are going to be explained as clear and also as accurate as possible how the reactor of the Pantone System works, because even the inventor, Paul Pantone, cannot explain them clearly at all.

#### How the reactor works:

The exhaust gas flows in the outside of the reactor (Figure 5.2 yellow arrows) with high kinetic energy. This allows raising very high temperature the steel rod that is used as a heat accumulator. Then part of the exhaust gas goes into the tank and the rest to the atmosphere as it has been said before.

Steam (volatilized or fuel) is released from the reservoir and sucked by the vacuum created by the inlet, and pushed by the pressure coming from the exhaust.

The kinetic energy of the steam increases with the reduction of the diameter of the inner cylinder caused by the Venturi effect that occurs in that section (see Figure 5.1 where says *south pole*)

The high temperature dominating inside the reactor and the increase of kinetic energy causes a thermo chemical dissociation of the volatilized fuel. This decomposition will allow the *electrification*: an expected phenomenon to be able the treatment of the mixture (in other case the reactor would only be a simple heat exchanger).

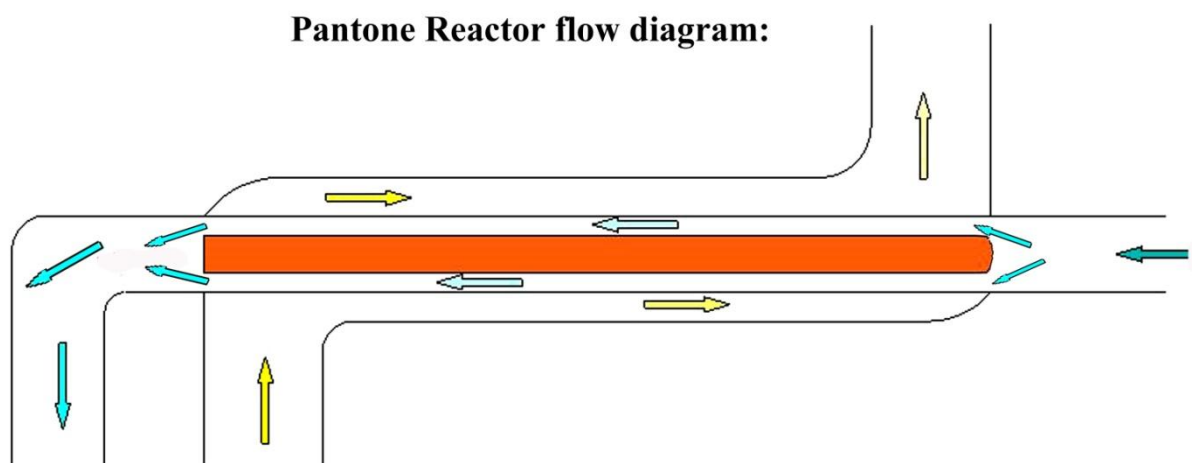

Figure 5.2 Flow Diagram



### Electrification:

In the first few centimeters travelled inside inner the tube, the fuel spray is transformed in dry steam by contact with hot walls. The micro-droplets of dry steam continue its progress in a very narrow space were they are electrified by friction. For this to happen the micro droplets need to move fast and neither the rod nor tube can be wet.

The micro-droplets and the molecules in the gas can easily be charged with electricity and now can be asked how they can get to the electrification. What is needed to know is that the molecules and micro-droplets are attracted and repulsion between them, and as they approach each other or are close to the wall, they are discharged immediately. Is guessed that they are charging, discharging, charging...continuously.

A small spark occurs at each charged and discharged, facilitating the dissociation of molecules or even drops into atoms (mostly **hydrogen** atoms).

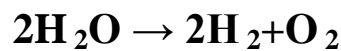

All those sparks are the source that increases the temperature at the end of reactor. This temperature is higher than the temperature of the exhaust.

This is a simplified description of the system as it has previously said the phenomenon is not completely known, even by the inventor who did not know how to explain this phenomenon. However, here is part of the question of how is formed the plasma inside the reactor.

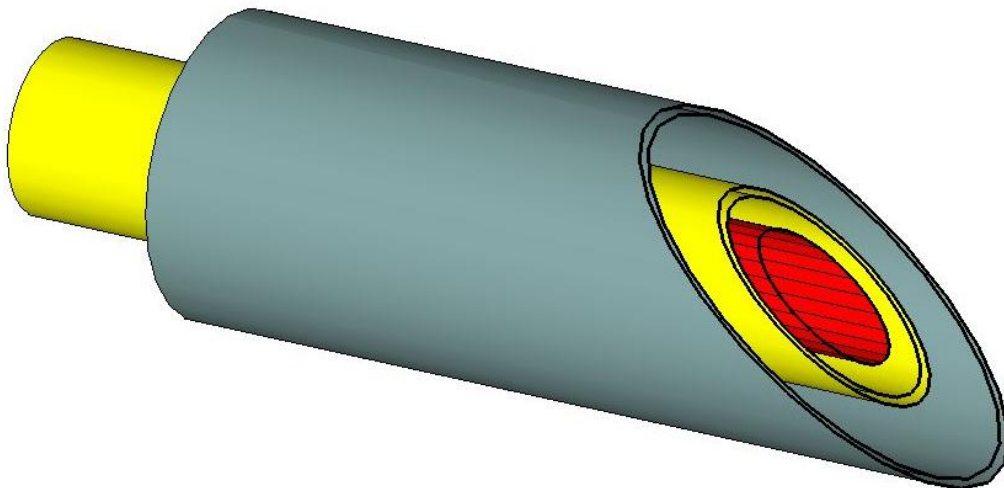

Figure 5.3 Detail of the reactor

### Operative mode:

To start properly the Pantone System is needed to be done within two stages of operation:

- The *bur-in time* period: start the system as a conventional engine. The exhaust gases pass through the outer tube and escaping into the atmosphere. The aim is to heat the reactor. Need to wait about twenty minutes before switching to *Pantone mode*.
- Operating different valves the engine is switched to work with the Pantone system. The gases then circulate as described above.

### 5.1.3 Components and Materials of the Pantone System

In this part of the report are going to be described different materials and components for a future manufacturing process of the Pantone System as far as detailed list of all the components with the necessary dimensions to manufacture it.

The materials from a technical point have to withstand high temperatures, higher than in a conventional engine (around 873 K) due to the process carried out inside the reactor, and have high thermal conductivity to transfer in the reactor between the two pipes as much energy as possible, in order to achieve the highest efficiency. Like copper or any alloy with great amount of this metal, or steel. Some parts of the system will have to be mechanized and/or threaded. It must be adjustable to obtain the best configuration, easy to install and remove for cleaning processes because it is very likely that the reactor will get dust from the mixture.

### List of Components:

Here is set the list of components necessary, according to the author<sup>xi</sup>, to do the conversion of a small engine into Pantone System:

## Fuel Processor:

- 1 - 16 7/16" x 1/2" Black Pipe - (Cut + Threaded)
- 1 - 12" x 1" Black Pipe Nipple (painted)
- 1 - 12" x 1/2" Steel Rod
- 2 - 1" x 1/2" x 1/2" Galvanized Reducing Tees (Ward - best)
- 2 - 22mm / 7/8" Copper Oil Drain Plug Washers
- 1 - 2" x 1/2" Galvanized Pipe Nipple
- 1 - 1/2" Galvanized Pipe Connector
- 1 - 1" Galvanized Pipe Hangar with Bolt & Nuts
- 3 - 1 1/2" x 1/2" Galvanized Pipe Nipples
- 1 - 3" x 1/2" Galvanized Pipe Nipple
- 3 - 1/2" NPT Ball Valves (B&K - best)
- 1 - 1/2" Galvanized NPT Muffler
- 2 - 1/2" Galvanized Pipe Tees
- 2 - 1/2" x 1/4" Galvanized Pipe Reducing Bushings
- 1 - Can Hi-Temp Grill Paint
- 27" - 1/2" Copper Tubing (\* 5/8")
- 2 - 1/2" NPT / 1/2 3/4" Brass Male Flare Fitting (\* 5/8")
- 2 - 1/2" Brass Flare Nuts (\* 5/8")

## Bubbler:

- 1 - 1 gallon Anti-Freeze Jug
- 4 - 1/2" Galvanized Hose Clamps
- 6' - 1/2" ID Clear Vinyl Hose - (cut in half)
- 2 - 3" x 1/4" Galvanized Pipe Nipples - (cut in half)
- 4 - 9/16" Galvanized Bushing Washers - (1/8" thick)
- 1 - 1/4" Galvanized Pipe Elbow
- 2 - 3/4" x 1/4" Galvanized Pipe Nipples
- 1 - 1/4" Galvanized Pipe Connector
- 1 - 10 3/4" x 1/2" Copper Water Pipe
- 1 - 1/2" Copper Pipe Cap
- 2 - 1/2" x 1/4" NPT Copper Pipe Adapters

### 5.1.4 Results

In this part of the report are presented the results obtained from the research of the Pantone System.

#### Effects in the engine:

Running an engine under the influence of the Pantone System changes a lot some of the main parameters of a conventional engine, like the timing, maximum pressure inside the combustion chamber...etc.

Some of them are beneficial, but others not. They are going to be discussed now.

There is going to be the next changes considered advantages about 20%:

- The pressure inside of the combustion chamber is going to be increased
- The power is going to be increased, but with the same consumption
- The pollutant emissions are going to be reduced

The increasing of the pressure is caused because more mixture is burn inside the cylinder, there is more carburant, the same fuel (petrol or diesel) but more chemical reactive available. The water when dissociated in the reactor into hydrogen and oxygen, those two products react each other again inside the cylinder adding their chemical energy to the one already available since the beginning.

The more pressure inside the combustion chamber, more work can be extracted from each stroke, the more power, but we are adding energy to the engine not from fossil fuel however from water, that can be easily and cheaply replaced. As a result the consumption is bigger but of water not of fuel.

Pollutant emissions can be reduced as part of the exhaust gasses are re-circulated again into the bubbler and other part is combined with the products of the combustion of hydrogen and oxygen, water.

However not all are advantages from the Pantone System, here are mentioned and later explained the disadvantages:

- The knocking tendency is going to be increased
- The wear of different parts are going to be increased
- The life of the engine is going to be reduced
- The pumping losses are going to be increased

The main reason of most of these inconveniences is a direct consequence of increasing of the pressure inside the combustion chamber. If the pressure is increased higher temperatures are going to be reached in the cylinder so the knocking tendency is going to be increased.

Also the wear of different parts are going to be increased because they are going to be under higher stress due to the more pressure produced in the combustion. A direct consequence of this is that the life of the engine will be shortened, because it will be working some kind of overloaded.

As the exhaust gasses are being used in the reactor making them to pass through more pipes of non constant sections, valves not designed for this use, and part of them re-circulated the exhaust pumping losses will be higher. The same way is going to be suffered in the intake, as all the mixture of fuel and water has to pass through the reactor, between a very narrow section, the volumetric efficiency is going to be reduced.

Another factor that derivates from the increased pressure will be higher temperature exhausts gasses that are a result of higher temperature in the combustion. This will be able to produce better dissociation reaction in the reactor.

### **Otto cycle changed due to the implementation of Pantone System:**

If we adapt the Pantone System and implement it into a petrol engine, the thermodynamic cycle will be affected and will change.

As in the reactor of the system  $H_2O$  is dissociated into  $H_2$  and  $O_2$ , the  $H_2$  plus  $O_2$  will be compressed in the combustion chamber of the engine. This will lead, as it has

already been said, to an increase of pressure, in the cycle, which means more surface on the Pressure-Volume ideal diagram of the Otto cycle of an engine. More positive area means more power; but also more negative area is created by the system meaning more pumping losses, as can be seen in Figure 5.4.

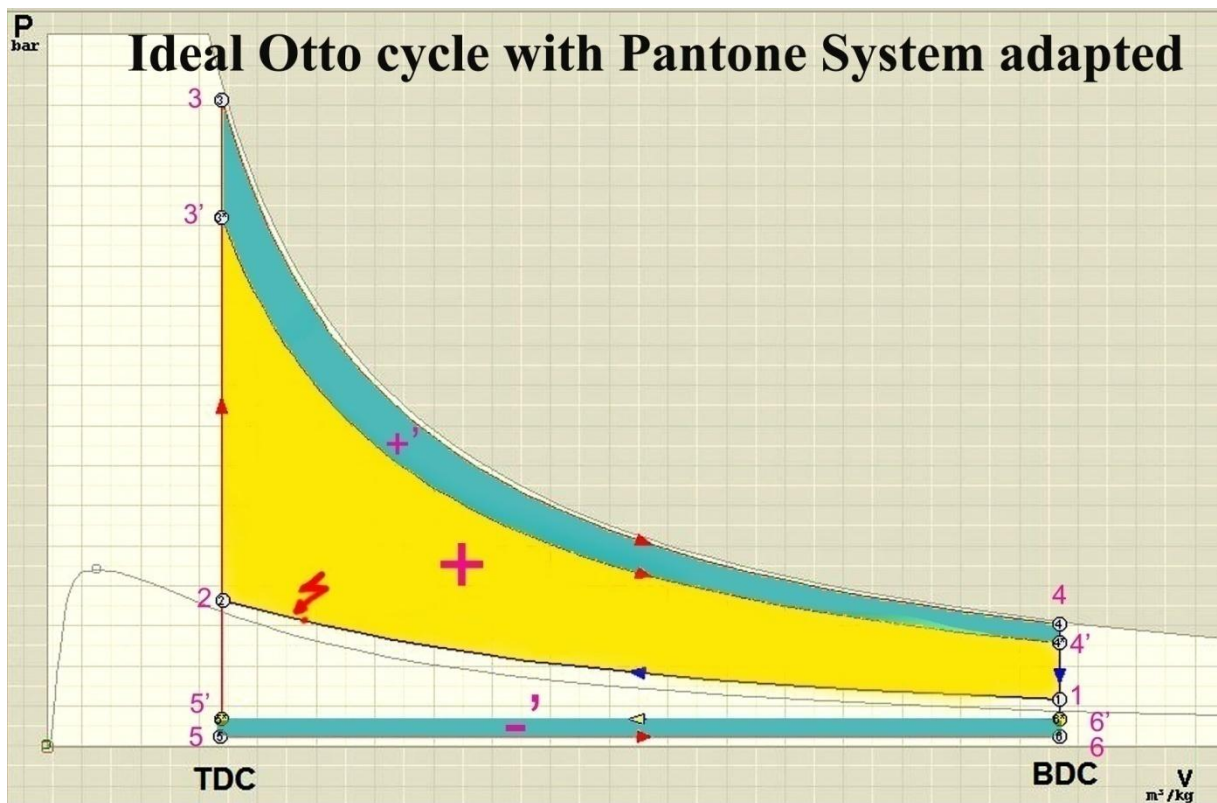

Figure 5.4 Ideal Otto cycle with Pantone System adapted

The yellow area is the original diagram before adapting the system in the engine, and after implementing the system the blue areas were added. It can be noticed that with the system more work is obtained from the cycle (positive blue area, +'), and also more losses from pumping (negative blue area, -').

From the point 1 to 2 is the compression stroke; during this stroke the spark plug is ignited. From 2 to 3' was the original combustion, which now goes to 3, more pressure is developed from the combustion of the mixture of hydrocarbons and  $H_2+O_2$ . The expansion stroke is from 3 to 4; previous to the implementation of the system was

from 3' to 4' what is less work obtained from the cycle without Pantone System.

The negative area is due to the increased pumping losses of the exhaust system caused by the reactor and all the modifications that has to be done to adapt the Pantone System. And also the volumetric efficiency is reduced in a similar way to the exhaust, due to the reactor and bubbler, producing bigger losses.

### **Balance of the system:**

If the original power of the engine is maintained, would be needed less fuel to obtain the same work from the cycle, reducing the fuel consumption and pollutant emissions.

Weighing up the advantages against all the disadvantages, the global result is that the system's advantages are beneficial.

The final **balance** between both works of the cycle is positive; the positive area is bigger than the losses, theoretically the system is **effective**.

## 5.2 Arturo Estévez Varela

Here is a reflection about the mentioned author who invented a hydrogen generator. This device is claimed to have worked properly, such a machine was built and developed by a man moving forward from his time; could have made real the dream of becoming water into fuel capable of propelling a vehicle with an internal combustion engine? Can we be in front of the father of a revolutionary invention?

### 5.2.1 Discussion

*“<sup>xii</sup>Arturo Estevez, the inventor of the hydrogen generator, claims that he can prove that his invention, which is 50,000 GBP, produces 350.000 kilograms of hydrogen. That is an energetic power of 1,400.000 liters of petrol. Now the chairman of the Centre of Study of Energy of Madrid is interested in it, who has asked for further information about the generator”.*

This new was published ruff at the beginning of the 80's. It leads to formulate

the question, if there has been a history of energetic discovery alternative to oil, developed in the anonymity through decades.

The today automotive industry situation is living a revolution focused in find alternatives to crude oil for propelling vehicles. The two and four stroke engines are threatened by a new generation clean propellants, which use bio-fuels obtained from plants or vegetable oils, electric energy or hydrogen. In fact thirty years ago this inventor sentenced: “<sup>xiii</sup>The hydrogen is the solution that the world has to survive”. But nobody seemed to believe him in those days.

### 5.3 Electrolysis's energy

Here is shown and worked out the energy necessary to dissociate water into hydrogen and oxygen, using electricity.

Energy to dissociate <sup>xiv</sup>1 litre of water in 1second:

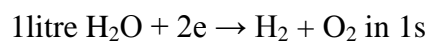

- 1 Coulomb =  $6,24 \times 10^{18}$  e
- 1 litre H<sub>2</sub>O (1000g) = 55,55 mol of water (18g = 1 mol of water)
- 2e x molec of H<sub>2</sub>O
  
- $55,55 \text{ mol} \rightarrow 55,55 \times 6,023 \times 10^{23} \text{ molec} \times 2e = \text{number of electrons (e)}$
- $\text{Coulombs} = 55,55 \times 6,023 \times 10^{23} \text{ molec} \times 2e / 6,24 \times 10^{18} e = 10,723 \times 10^6 \text{ [C]}$
  
- $I = q/t = 10,723 \times 10^6 \text{ [C]} / 1 \text{ s} = 10,723 \times 10^6 \text{ [A]}$
- $P = I \times V = 10,723 \times 10^6 \text{ [A]} \times 110 \text{ [v]} = 1,177 \times 10^7 \text{ [w]}$
- $E = P/t = 1,177 \times 10^7 / 1 = 1,177 \times 10^7 \text{ [J]}$

**1,177 E7 [J]**, the energy needed to to dissociate 1 litre of water in 1second.



## 5.4 Objectives achieved

The objectives achieved of this project about the Pantone System are the following ones:

- Scientific research about it and other technologies with common points
- The Pantone System has been understood theoretically, how it works
- It works in theory
- Effects that it produces have been described
- Advantages
- Disadvantages
- Future actions (recommendations)

## 5.5 Discussion

For developing this project it has mainly been used internet source, because there is mainly nothing published in books about Pantone, making the research very carefully in terms of authenticity due to the dangers that online data involves. Furthermore the information and data found varied a lot depending on whom and where has been published. However about thermodynamics, there is plenty of bibliography in any library, and the books are pretty always the same in any university.

Also lots of opinions <sup>xv</sup> are given without too much scientific background. So sometimes the feedback of the research about the Pantone System as result of that founds was sometimes quiet exasperating.

Nowadays with the automobile industry crisis, and the need of reducing the pollutant emissions, new ways of making engines more environmentally friendly are being developed by the big car manufacturer's companies. In this context such a system like Pantone's would be a big first step in the way to cut down the dependency of automotive on petrol.

Another question is why Pantone's Theory has not been studied before, because it was developed long time ago (patented in 1998, although developed

before). And even before, there were other inventions, as it has been explained before (Jean Chambrin, Arturo Estévez Varela) that tried to develop other ways of propelling automobiles.

## 6. CONCLUSIONS

In these times of excessive energy consumption based on fossil fuels and energy crisis, this system, in addition to be fuel saver, is environmental friendly, must move from a theoretical concept to a practical development from an engineering point of view. From a theoretical point of view has been seen that the Pantone System works and that the balance between advantages and disadvantages is positive.

The time has come, despite the global economic crisis, to invest sources (economic, technical, human...etc) for developing and improving systems, like the Pantone System, for turning them profitable and that could be adapted into the actual internal combustion engines for using other carburant or other ways of combustion that until not so long where few developed or unknown. With the value of trying to solve the dependence on crude oil of our society and try to preserve the environment. Would be very good if a new system of this kind could be implanted into mass production vehicles or generators, specially these ones because of their nature of stationary engines working under constant parameters could be relatively easy to reach higher efficiencies than nowadays.

## 7. RECOMMENDATIONS

Is strongly suggested to build a prototype (because that project was too big, difficult and expensive to be carried out by only one alum) with the suitable measurement systems and sensors precise and reliable enough to prove (or not) the practical working of the system. And if so that could be a great benefit for the automotive industry. Using the suitable manufacturing techniques and materials to develop specifications needed to make the system compatible with different types and configuration of engines.

**BIBLIOGRAPHY:**

**STONE, R.** Introduction Internal Combustion Engines. (SAE Publications).

**HEYWOOD, J.B.** Internal Combustion Engines Fundamentals. (McGraw-Hill).

**MORAN Y SHAPIRO** Fundamentos de Termodinámica (Editorial Reverte).

**AGUILAR PERIS J.** 1989 Curso de Termodinámica. (Madrid, Editorial Alhambra).

**GIACOSA, D.** Motores Endotérmicos (Barcelona, Ediciones Omega).

**BROATCH JACOBI, A., GALINDO LUCAS, J., PAYRI MARIN, R.** 1998 Problemas de Ingeniería Térmica. (Valencia, Universidad Politécnica de Valencia).

**WHITE F.M.** 1983 Mecánica de Fluidos, (Valencia, Madrid, McGraw-Hill).

**LASHERAS, J.M.-CARRASQUILLA, J.F.** 1992 Ciencia de Materiales (Editorial Obelisco).

**CENGEL, VUNUS** Transferencia De Calor Y De Masa (Madrid, McGraw-Hill).

**AROCA LASTRA, SANTIAGO-ANDRÉS POMATTA-RODRÍGUEZ-POMATTA** Transmisión Del Calor (Universidad Nacional de Educación a Distancia. U.N.E.D).

**MATEOS M.** 1990 Válvulas para abastecimiento de aguas (Madrid, Ediciones Bellisco).

**BAHER** Tratado moderno de Termodinámica (Editorial Tecnilibro).

**MUÑOZ, N. Y PAYRI, F.** Motores de Combustión Interna Alternativos. (E.T.S.I. Industriales de Madrid, Madrid).

**AGUAS ALCALDE, J.J.** 101 Problemas Resueltos de Ingeniería Térmica (Pamplona, Ulzama Ediciones).

**FERGUSON, C.R.** Internal Combustion Engines (John Wiley & Sons).

**TAYLOR, C.** The Internal Combustion Engines in Theory and Practice (The MIT Press).

**INCROPERA, DEWITT, BERGMAN, LAVINE** Introduction to Heat Transfer  
(WILEY)

*Controversy:* (online), retrieved via Firefox. 20 Oct 2008

<http://freeenergynews.com/Directory/Geet/controversy.htm>

*Cold Fussion:* (online), retrieved via Firefox. 25 Oct 2008

<http://www.youtube.com/watch?v=uMFvzohuVew&feature=related>

*GEET Explanation:* (online), retrieved via Firefox. 1 Nov 2008

<http://www.youtube.com/watch?v=a2KRRgjcJTg&NR=1>

*Paul Pantone:* (online), retrieved via Firefox. 5 Nov 2008

<http://www.geet-pantone.com/newsarticle.htm>

*Enduro Motorbikes Webpage ;* (online), retrieved via Firefox 19 Nov. 2008

<http://www.endureros.com/moto-enduro-postp529322.html>

*Video:* (online), retrieved via Firefox 19 Nov. 2008

<http://uk.youtube.com/watch?v=XYexXWPapAg&eurl=http://www.endureros.com/motoenduro-postp529322.html>

*Alasbarricadas-Foro. Ver Tema- Motor de hidrogeno; "Pantone and Hydrogen Engines..."* retrieved via Firefox 25 Nov. 2008

<http://www.alasbarricadas.org/forums/viewtopic.php?f=13&t=1648&start=60&st=0&sk=t&sd=a>

*FREE - GEET Fuel Processor Plans:* ; (online), retrieved via Firefox 28 Nov. 2008

<http://teslatech.info/ttstore/articles/geet/geet.htm>

*The GEET Fuel Processor is a self-inducing Plasma generator.* ; (online), retrieved via Firefox 29 Nov. 2008

<http://www.geet-pantone.com/self.htm>

*pantone patent "USoo5794601A1 patent"* ;(online), retrieved via Firefox 30 Nov. 2008

<http://www.rexresearch.com/pantone/pantone.htm>

*Waterpoweredcar* ;(online), ;(online), retrieved via Firefox 31 Nov. 2008

<http://www.waterpoweredcar.com/>

*Patentan un motor que funciona parcialmente con agua*;(online), retrieved via Firefox 6 Dec. 2008

<http://blog.pucp.edu.pe/item/7400>

*Motor de agua bendita (HOY.es)*. ;(online), retrieved via Firefox 6 Dec. 2008

[http://www.hoy.es/prensa/20061016/regional/motor-agua-bendita\\_20061016.html](http://www.hoy.es/prensa/20061016/regional/motor-agua-bendita_20061016.html)

*Franco mando parar el motor de agua (HOY.es)*. ;(online), retrieved via Firefox 7 Dec. 2008

[http://www.hoy.es/prensa/20061112/sociedad/franco-mando-parar-motor\\_20061112.html](http://www.hoy.es/prensa/20061112/sociedad/franco-mando-parar-motor_20061112.html)

*El revolucionario invento de un extremeño..... (Arturo Estévez Varela) (HOY.es)*. (online), retrieved via Firefox 8 Dec. 2008

[http://www.hoy.es/prensa/20061016/regional/revolucionario-invento-extremeno-cobra\\_20061016.html](http://www.hoy.es/prensa/20061016/regional/revolucionario-invento-extremeno-cobra_20061016.html)

*El hidrogeno como combustible tardara en llegar (HOY.es)*. ;(online), retrieved via Firefox 9 Dec. 2008

[http://www.hoy.es/prensa/20061016/regional/hidrogeno-como-combustible-tardara\\_20061016.html](http://www.hoy.es/prensa/20061016/regional/hidrogeno-como-combustible-tardara_20061016.html)

*Stanley Meyers*; “*invented an engine that can run with water*” ;(online), retrieved via Firefox 12 Dec. 2008

<http://www.antoandreu.com/2008/03/03/stanley-meyers-el-inventor-del-motor-de-agua-para-los-coches/>

*Stanley MEYER Water Electrolysis. Canadian Patent # 2,067,735 Water Fuel Injection System*: ;(online), retrieved via Firefox 10 Dec. 2008

<http://www.rexresearch.com/meyerhy/2067735.htm>

*Stanley Meyer Files*: ;(online), retrieved via Firefox 18 Dec. 2008

<http://waterpoweredcar.com/stan.html>

*Stanley Meyer Webpage*: ;(online), retrieved via Firefox 18 Dec. 2008

<http://www.waterfuelcell.org/>

*Stanley Meyer Webpage*: ;(online), retrieved via Firefox 22 Dec. 2008

<http://www.waterfuelcell.org/concept.html>

*Stanley Meyer Webpage*: ;(online), retrieved via Firefox 5 Jan. 2008

<http://waterpoweredcar.com/stan.html>

*GEET - an effort at replication*; (online), retrieved via Firefox 10 Jan. 2009

<http://www.phact.org/e/z/geet.htm>

*GEET-Pantone Multi-fuel Plasma Reactor Research-Workshop* ; (online), retrieved via Firefox 10 Jan. 2009

<http://geetpantone.blogspot.com/>

*GEET Pantone plasma systems-GEET Fuel Processor*; (online), retrieved via Firefox 10 Jan. 2009

<http://www.geet.nl/nieuwsartikel.php?id=66>



*Pantone Syst. for a big Lawnmower in France:* (online), retrieved via Firefox 12 Jan. 2009

[http://66.196.80.202/babelfish/translate\\_url\\_content?lp=fr\\_en&trurl=http%3A%2F%2Fperso.wanadoo.fr%2Fquanthomme%2Fhistspmcfrance.htm&.intl=us](http://66.196.80.202/babelfish/translate_url_content?lp=fr_en&trurl=http%3A%2F%2Fperso.wanadoo.fr%2Fquanthomme%2Fhistspmcfrance.htm&.intl=us)

*Jean Chambrin; Developed a Water-Alcohol Motor (patent numbers WO8204096 and WO8203249);* (online), retrieved via Firefox 12 Jan. 2009

<http://www.rexresearch.com/chambrin/chambrin.htm>

*ECOLOGIE MARTZ;* (online), retrieved via Firefox 10 Feb. 2009

[http://quanthomme.free.fr/pantone/martz/SyntheseC\\_Martz.htm](http://quanthomme.free.fr/pantone/martz/SyntheseC_Martz.htm)

*Francés que investiga el sistema Pantone;* (online), retrieved via Firefox 16 Feb. 2009

[http://quanthomme.free.fr/pantone/martz/En\\_geet.htm](http://quanthomme.free.fr/pantone/martz/En_geet.htm)

*Síntesis del trabajo;* (online), retrieved via Firefox 20 Feb. 2009

[http://quanthomme.free.fr/pantone/martz/PageC\\_Martz.htm](http://quanthomme.free.fr/pantone/martz/PageC_Martz.htm)

*Pantone Geet Alternative Energy Show and Tell;* (online), retrieved via Firefox 10 march. 2009

<http://energyshowandtell.wetpaint.com/page/Pantone+Geet?t=anon>

**REFERENCES:**

---

<sup>i</sup> A.F., 2009 “Los cuatro tiempos del agua” *EL PAIS-MOTOR*, 39, p10

<sup>ii</sup> (online), retrieved by Firefox

[www.HOY.es](http://www.HOY.es)

[http://www.hoy.es/prensa/20061016/regional/revolucionario-invento-extremeno-cobra\\_20061016.html](http://www.hoy.es/prensa/20061016/regional/revolucionario-invento-extremeno-cobra_20061016.html)

<sup>iii</sup> *Stanley Meyer: Invented an engine that can run with water* (online), retrieved by Firefox:

<http://www.waterfuelcell.org/>

*Stanley Meyer:*

<http://www.waterfuelcell.org/concept.html>

*Stanley Meyer:*

<http://waterpoweredcar.com/stan.html>

<sup>iv</sup> *Canadian Patent # 2,067,735 Water Fuel Injection System* (online), retrieved by Firefox:

<http://www.rexresearch.com/meyerhy/2067735.htm>

<sup>v</sup> *Jean Chambrin; Developed a Water-Alcohol Motor (patent numbers WO8204096 and WO8203249)* (online), retrieved by Firefox:

<http://www.rexresearch.com/chambrin/chambrin.htm>

<sup>vi</sup> *Paul Pantone GEET Fuel Pretreater* (online), retrieved by Firefox:

<http://www.rexresearch.com/pantone/pantone.htm>

---

vii *GEET Pantone Plasma Systems*(online), retrieved by Firefox:

<http://www.geet.nl/nieuwsartikel.php?id=66>

viii *GEET Pantone plasma systems-GEET Fuel Processor* (online), retrieved by Firefox:

<http://www.geet.nl/nieuwsartikel.php?id=66>

ix **STONE, R.** *Introduction Internal Combustion Engines.* (SAE Publications).

x **HEYWOOD, J.B.** *Internal Combustion Engines Fundamentals.* (McGraw-Hill).

xi *FREE - GEET Fuel Processor **Plans**:*

<http://teslatech.info/ttstore/articles/geet/geet.htm>

xii *A.F., 2009 “Los cuatro tiempos del agua” EL PAIS-MOTOR, 39, p10*

xiii *Diario HOY.* [www.HOY.es](http://www.HOY.es)

xiv <http://www.todoexpertos.com/categorias/ciencias-e-ingenieria/ingenieria-quimica/respuestas/1993363/energia-para-la-electrolisis>

xv *GEET - an effort at replication:*

<http://www.phact.org/e/z/geet.htm>